

## Food Microbiology

October 2015



*Edition*

Version 1 (2015-11-26)

*Editor in chief*

Hans Lindmark, head of Biology department, National Food Agency

*Responsible for the scheme*

Laurence Nachin, microbiologist, Biology department, National Food Agency

PT October 2015 is registered as no. 2015/0764 at the National Food Agency.

*Proficiency Testing*  
**Microbiology – Food**

October 2015



1457  
ISO/IEC 17043

**Quantitative analyses**

- Aerobic microorganisms, 30 °C
- Aerobic microorganisms, 20 °C
- Contaminating microorganisms in dairy products
- Enterobacteriaceae
- Coliform bacteria 30 °C
- Coliform bacteria 37 °C
- Thermotolerant coliform bacteria
- *Escherichia coli*
- Presumptive *Bacillus cereus*
- Coagulase positive staphylococci
- Enterococci

**Qualitative analyses**

- Gram-negative bacteria in pasteurized dairy products

## Abbreviations

---

### Media

BcS	Bacillus cereus Selective agar
BGB	Brilliant Green Broth
BP	Baird-Parker agar
EC medium	Escherichia coli medium
PCA	Plate count agar
LTLSB	Lactose Tryptone Lauryl Sulphate Broth
MPCA	Milk Plate Count agar
MPN	Most Probable Number
MYP	Mannitol-Egg Yolk-Polymyxin agar
RPF	Rabbit Plasma Fibrinogen
S&B	Slanetz & Bartley agar
TBX	Tryptone Bile X-Glucuronide agar
TSA	Trypticase Soy agar
TGE	Tryptone Glucose Extract agar
VRB	Violet Red Bile agar
VRBG	Violet Red Bile Glucose agar

### Organisations

IDF	International Dairy Federation
ISO	International Organization for Standardization
NMKL	Nordic Committee for Food Analyses
SLV/NFA	Livsmedelsverket/National Food Agency, Sweden

## Contents

---

General information on results evaluation.....	4
Results of the PT round October 2015 .....	5
- General outcome .....	5
- Aerobic microorganisms, 20 °C and 30 °C .....	6
- Contaminating microorganisms in dairy products.....	7
- Enterobacteriaceae .....	8
- Coliform bacteria 30 °C and 37 °C.....	9
- Thermotolerant coliform bacteria and <i>Escherichia coli</i> . .....	10
- Presumptive <i>Bacillus cereus</i> .....	12
- Coagulase positive staphylococci .....	12
- Enterococci .....	13
- Gram-negative bacteria in pasteurized dairy products .....	14
Outcome of the results of individual laboratory – assessment .....	15
- Box plot .....	16
Test material and quality control .....	21
- Test material .....	21
- Quality control of the mixtures .....	22
References .....	23
Annex 1: Results obtained by the participants	
Annex 2: z-scores of all participants	
Annex 3: Youden plot for mixture B/C	

# General information on results evaluation

## Statistical evaluation of the results

Highly deviating values that did not belong to a strictly normal distribution were identified as statistical outliers (Grubbs' test modified by Kelly (1)). In some cases, subjective adjustments were made to set limits, based on knowledge of the mixture's contents. Outliers and false results were not included in the calculations of means and standard deviations. Results reported as ">value" were excluded from the evaluation. Results reported as "<value" were interpreted as being zero (negative result). All reported results are presented in Annex 1.



According to EN ISO/IEC 17043, for which the proficiency testing programme organised by the National Food Agency is accredited since early 2012, it is mandatory for the participating laboratories to give method information for all analyses for which they report results. Method information is sometimes difficult to interpret, e.g several laboratories choose a medium that differs from that in the reported standard methods. Therefore, in the following section, results have been grouped according to the method or the medium used to perform the analysis.

## Uncertainty of measurement for the assigned values

The uncertainty of measurement for an assigned value is calculated as the standard deviation divided by the square root of the number of correct results ("standard error"). The assigned value of evaluated parameters is the mean value of the participants results.



## Tables and figures legend

### Tables

n	number of laboratory that performed the analysis
m	results mean value in $\log_{10}$ cfu/ml (false results and outliers excluded)
s	results standard deviation
F	number of false positive or false negative results
<	number of low outliers
>	number of high outliers
	global results for the analysis
	values discussed in the text

### Figures

Histograms of all analytical results obtained for each mixture are presented. The mean value of the analysis results is indicated in each histogram.

	values within the interval of acceptance (Annex 1)
	outliers
	false negative results
*	values outside of the x-axis scale

# Results of the PT round October 2015

## General outcome

Samples were sent to 186 laboratories, 49 in Sweden, 118 in other European countries, and 19 outside Europe. 177 laboratories reported results, 85 (48 %) provided at least one result that received an annotation. In the previous round (October 2014) with similar analyses, the proportion was 46 %.

Individual results for each analysis of the PT round are listed in annex 1 and are also available on the website after logging in: [www2.slv.se/absint](http://www2.slv.se/absint).

**Table 1** Microorganisms in each mixture and % of deviating results (F%: false positive or false negative, Out: outliers).

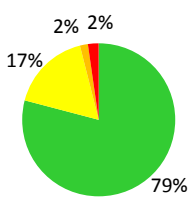
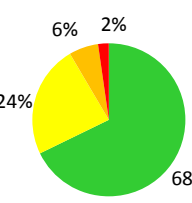
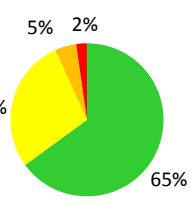
		Mixture A			Mixture B			Mixture C		
% participants with										
		2% 2% 17% 79%			6% 2% 24% 68%			5% 2% 28% 65%		
<b>Organisms</b>		<i>Klebsiella pneumoniae</i> <i>Escherichia coli</i> <i>Enterococcus faecium</i>			<i>Providencia alcalifaciens</i> <i>Staphylococcus aureus</i> <i>Bacillus cereus</i>			<i>Providencia alcalifaciens</i> <i>Staphylococcus aureus</i> <i>Bacillus cereus</i>		
<b>Analysis</b>		<b>Target</b>	<b>F%</b>	<b>Out</b>	<b>Target</b>	<b>F%</b>	<b>Out</b>	<b>Target</b>	<b>F%</b>	<b>Out</b>
Aerob. microorg.	30 °C	<i>K. pneumoniae</i>	0	8	<i>P. alcalifaciens</i>	0	4	<i>P. alcalifaciens</i>	0	4
	20 °C	<i>E. coli</i>	0	9	<i>S. aureus</i>	0	3	<i>S. aureus</i>	0	3
Contaminating microorg.		<i>E. faecium</i>	11	0	<i>B. cereus</i>	0	0	<i>B. cereus</i>	0	0
Enterobacteriaceae		<i>K. pneumoniae</i>	1	2	<i>P. alcalifaciens</i>	5	4	<i>P. alcalifaciens</i>	4	5
Coliforms	30 °C	<i>E. coli</i>	2	4	<i>(P. alcalifaciens)</i>	30	-	<i>(P. alcalifaciens)</i>	30	-
	37 °C		0	3		20	-		24	-
Thermotol. coliform		<i>K. pneumoniae</i>	0	0	-	2	0	-	2	0
<i>E. coli</i>		<i>E. coli</i>	0	6	-	3	-	-	3	-
Presump. <i>B. cereus</i>		-	2	-	<i>B. cereus</i>	5	2	<i>B. cereus</i>	7	2
Coag. pos. Staph.		-	5	-	<i>S. aureus</i>	2	5	<i>S. aureus</i>	2	5
Enterococci		<i>E. faecium</i>	3	6	-	1	-	-	1	-
Gram-neg microog. in past. dairy prod.		<i>K. pneumoniae</i>	0	-	<i>P. alcalifaciens</i>	9	-	<i>P. alcalifaciens</i>	8	-
		<i>E. coli</i>								

- : no target organism or no value; (*microorganism*): false positive before confirmation

In this round mixture B and C were one and the same, therefore in the following tables results reported for the two mixtures were evaluated together.

## Aerobic microorganisms, 20 °C and 30 °C

### Mixture A

All strains contained in mixture A build colonies on PCA but the one counted for these analyses were mainly from *Enterococcus faecium* present at the highest concentration.

### Mixture B/C

Colonies of *Providencia alcalifaciens*, *Bacillus cereus* and *Staphylococcus aureus* were counted for these analyses.

### Results of aerobic microorganisms analysis, 20°C

Medium	Mixture A						Mixture B/C					
	n	m	s	F	<	>	n	m	s	F	<	>
Total	34	4.01	0.07	0	0	3	68	4.85	0.18	0	0	2
PCA	24	4.00	0.06	0	0	3	48	4.83	0.15	0	0	2
Petrifilm™	5	4.06	0.08	0	0	0	10	5.03	0.11	0	0	0

A

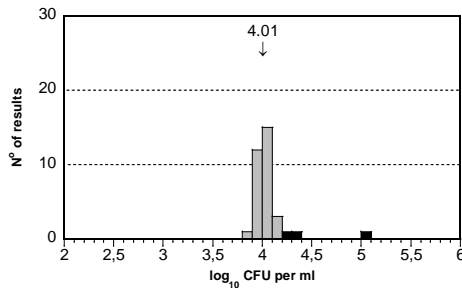

A

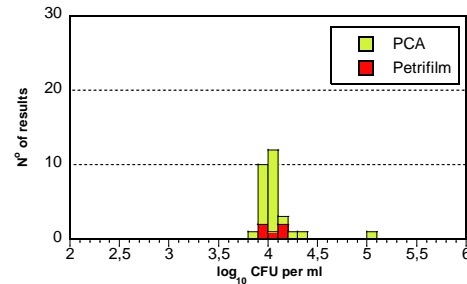

B/C

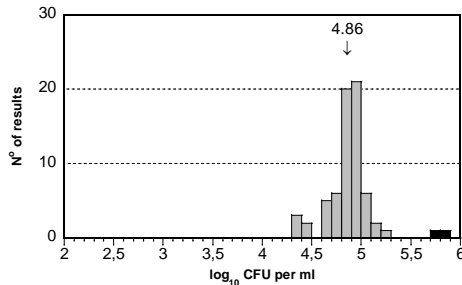

B/C

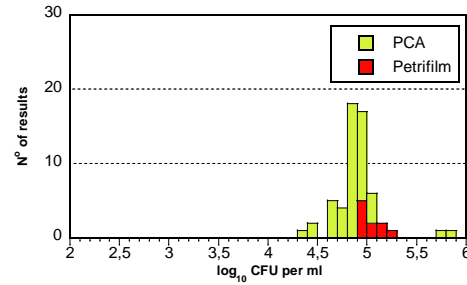

### Results of aerobic microorganisms analysis, 30°C

Medium	Mixture A						Mixture B/C					
	n	m	s	F	<	>	n	m	s	F	<	>
Total	166	4.03	0.08	0	5	9	317	4.92	0.16	0	10	4
PCA	94	4.02	0.08	0	2	4	188	4.88	0.14	0	3	2
Petrifilm™	33	4.07	0.08	0	2	2	66	5.01	0.12	0	4	0
MPCA	20	4.06	0.06	0	0	1	39	4.93	0.09	0	0	0
TSA	9	4.03	0.04	0	0	0	18	4.92	0.20	0	0	0

A

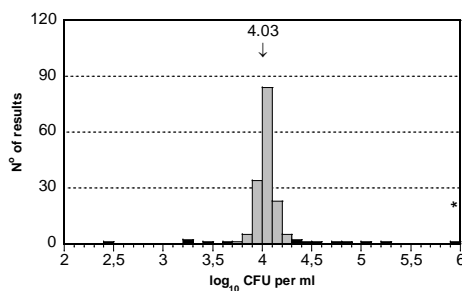

A

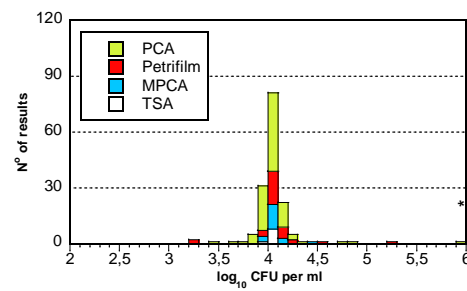



B/C

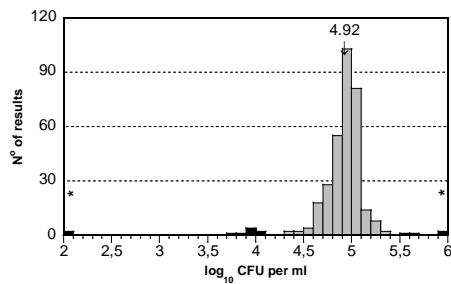

B/C

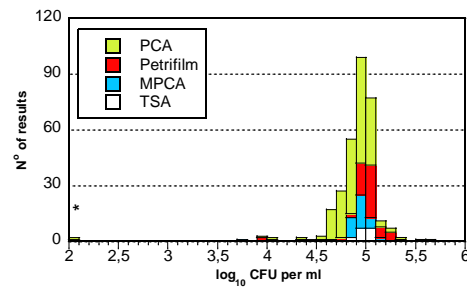

There are no significant differences in results depending on the medium chosen for the analysis of aerobic microorganisms at 20°C or 30°C. For mixtures B/C, results obtained with the use of Petrifilm™ tend to be higher than the general results average. This suggests that in these cases, the indicator dye present in Petrifilm™ could facilitate the enumeration of colonies and therefore lead to higher counts.

## Contaminating microorganisms in dairy products

### Mixture A

At NFA, we counted three morphologically different types of colonies, indicating that the three strains present in mixture A can form colonies on Sugar-Free Agar i.e. *Enterococcus faecium*, *Klebsiella pneumoniae* and *Escherichia coli*.

### Mixture B/C

Like for the analysis of aerobic microorganisms, colonies from all strains present in mixture B/C were counted.

#### Results of contaminating microorganisms analysis

Confirmation	Mixture A						Mixture B/C					
	n	m	s	F	<	>	n	m	s	F	<	>
Total	18	3.78	0.46	2	0	0	36	4.73	0.44	0	0	0
Yes	8	3.61	0.28	1	0	0	16	4.97	0.11	0	0	0
No	7	4.02	0.41	1	0	0	16	4.59	0.46	0	0	0

A

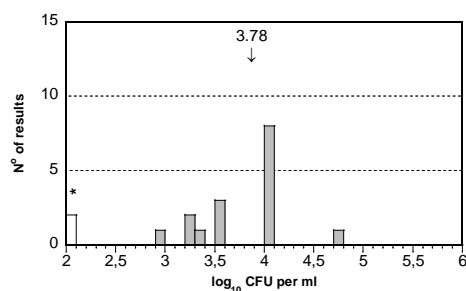

A

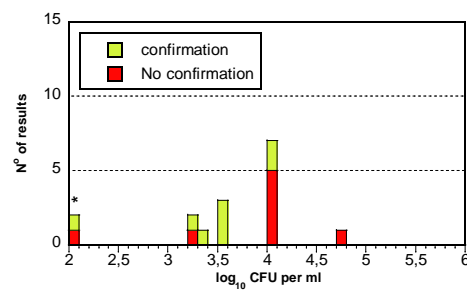

B/C

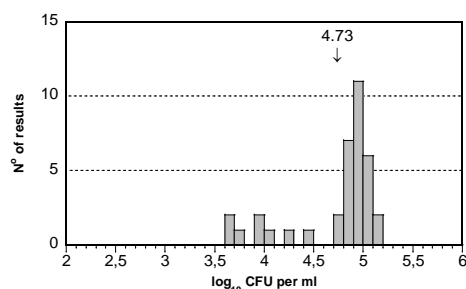

B/C

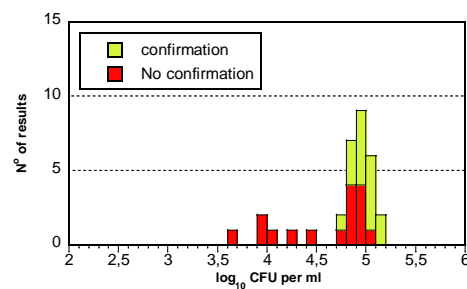

Few laboratories performed this analysis and the results are spread for all mixtures which make it impossible to identify outliers. Approximately half of the laboratories reported to follow the standard method ISO 13559:2002 / IDF 153:2002, but almost all used the same medium, sugar-free agar.

The analysis aim is to identify potential contaminating non-lactic acid bacteria in dairy products. Lactic acid bacteria are catalase negative, therefore some laboratories use this test as confirmation in order to decide which colonies to count on the plates. Half of the laboratories performed a catalase test.

Mixture A contained a strain of *Enterococcus faecium*, present at the highest concentration that is catalase negative. This could explain the slightly lower count of colonies reported when a catalase test was performed.

For mixture B/C, results are more difficult to explain: *P. alcalifaciens*, *B. cereus* and *S. aureus* are all catalase positive; this implies that laboratories should have counted all colonies regardless if they have performed a catalase test or not. However laboratories that did not perform confirmation step reported lower and more spread results. The method ISO 13559:2002 / IDF 153:2002 does not state any confirmation test, but excludes pin-point colonies from the counting. Some laboratories not performing the catalase test might have excluded smaller colonies from their count while other have counted all of them, thus explaining the large dispersion of results. On the other hand laboratories that performed the catalase test probably counted all colonies that grew on the plate and therefore reported similar results.

## Enterobacteriaceae

### Mixture A

Both *Escherichia coli* and *Klebsiella pneumoniae* were target-organisms for these analyses.

### Mixture B/C

A strain of *Providencia alcalifaciens* was target-organism for this analysis. When controlling the mixture, this strain formed typical colonies on VRBG that were oxidase negative after re-streaking on non-selective medium. Seven laboratories (out of 138) reported a false negative result for this analysis.

### Results of enterobacteriaceae analysis

Medium	Mixture A						Mixture B/C					
	n	m	s	F	<	>	n	m	s	F	<	>
Total	138	3.39	0.19	1	3	0	275	4.79	0.13	13	10	3
VRBG	102	3.37	0.20	0	3	0	203	4.79	0.12	3	7	2
Petrifilm™	32	3.43	0.12	0	1	0	64	4.78	0.15	10	3	1

A

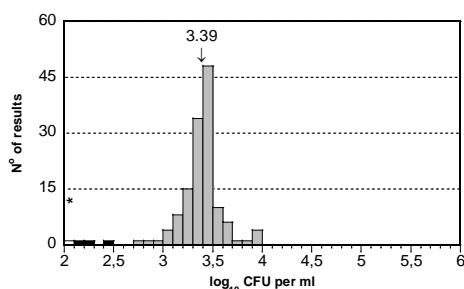

A

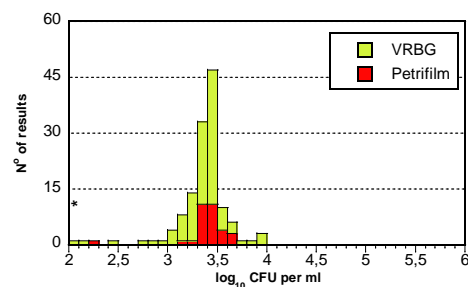

B/C

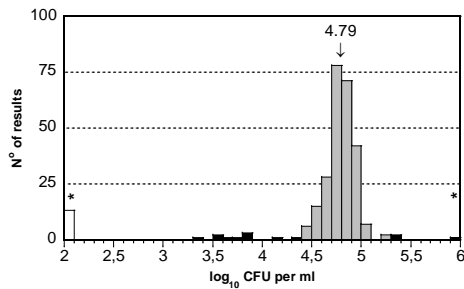

B/C

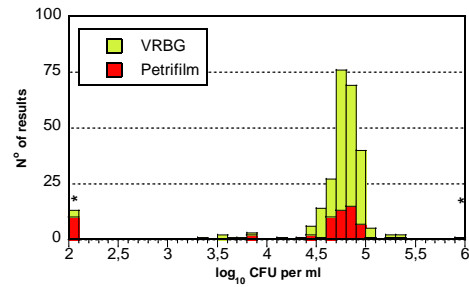

Most of the false negative results reported for mixture B/C are linked to the use of Petrifilm™ Enterobacteriaceae. During the control of mixture B/C we did not use Petrifilm™, therefore it is difficult to know the reason for such correlation. We can only speculate that colonies of *P. alcalifaciens* were more difficult to read on Petrifilm™ than on VRBG plate.

## Coliform bacteria 30°C and 37°C

### Mixture A

Both *Escherichia coli* and *Klebsiella pneumoniae* were target-organisms for these analyses.

### Mixture B/C

There was no target-organism for these analyses in mixture B/C. After incubation both at 30°C and 37°C *Providencia alcalifaciens* formed small colonies on VRB that could be suspected as colonies from coliform bacteria. However, during confirmation, unlike coliform bacteria *P. alcalifaciens* does not ferment lactose in BGB. Out of the 56 laboratories that performed the analysis at 30°C and the 93 laboratories that performed the analysis at 37°C, 17 and 22 reported a false positive result, respectively.

### Results of coliform bacteria analysis, 30°C

Medium	Mixture A						Mixture B/C					
	n	m	s	F	<	>	n	m	s	F	<	>
Total	56	3.30	0.24	1	1	1	112	-	-	34	-	-
VRB	42	3.29	0.23	1	1	1	84	-	-	22	-	-
TSA/VRB	4	3.37*	-	0	0	0	8	-	-	0	-	-
Petrifilm™ CC	4	3.30*	-	0	0	0	8	-	-	8	-	-
Petrifilm™ EC/CC	3	3.28*	-	0	0	0	6	-	-	2	-	-

\* median

A

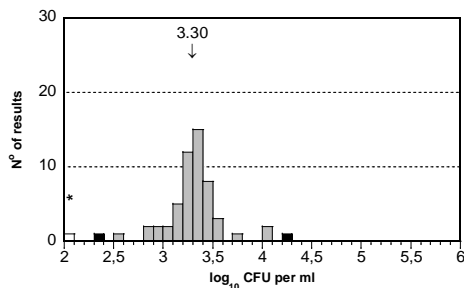

A

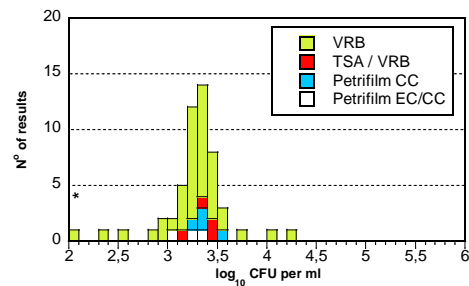

### Results of coliform bacteria analysis, 37°C

Medium	Mixture A						Mixture B/C					
	n	m	s	F	<	>	n	m	s	F	<	>
Total	94	3.32	0.28	0	1	2	186	-	-	41	-	-
VRB	49	3.33	0.33	0	0	0	98	-	-	28	-	-
TSA/VRB	7	3.43	0.06	0	0	0	14	-	-	2	-	-
Petrifilm™ CC	10	3.34	0.10	0	0	0	20	-	-	5	-	-
Petrifilm™ EC/CC	11	3.33	0.17	0	0	0	22	-	-	2	-	-

A

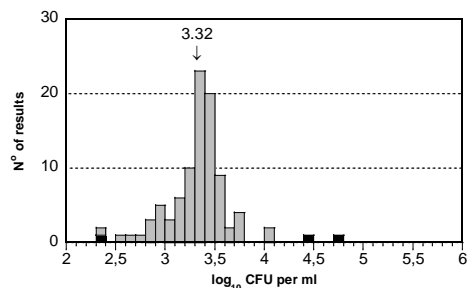

A

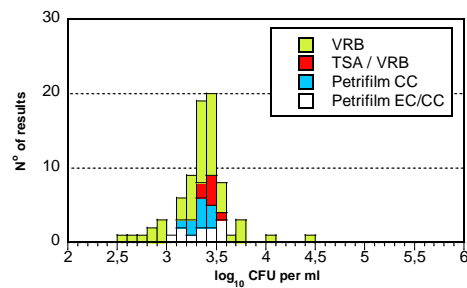

For mixture A and at both temperatures, results were slightly higher when analyses were performed with TSA/VRB. Pre-incubation in TSA can help for a better recovery if bacteria were stressed in the sample and is recommended in method NMKL 86:2004.

For mixture B/C many laboratories reported a false positive result. For half of them it can be explained by the absence of confirmation step. For the other half, we can only speculate that the confirmation step was not performed properly and gave an erroneous result. In both methods NMKL 44:2004 and ISO 4832:2006 the identification of coliforms is confirmed by fermentation of lactose in BGB. This confirmation is prescribed for all suspected colonies in the NMKL method but only for atypical colonies in the ISO method.

### Thermotolerant coliform bacteria and *Escherichia coli*

#### Mixture A

Both *Escherichia coli* and *Klebsiella pneumoniae* are thermotolerant coliform bacteria. During our control we found it difficult to distinguish between the two colonies kind on TSA/VRB if the plates were not read directly after incubation at 44°C. For the confirmation steps, both strains ferment lactose at 44°C, but only *E. coli* is positive for the indol test after growth in LTLNB at 44°C.

#### Mixture B/C

There was no target-organism for these analyses in Mixture B/C.

### Results of thermotolerant coliforms analysis

Medium	Mixture A						Mixture B/C					
	n	m	s	F	<	>	n	m	s	F	<	>
Total	54	3.28	0.34	0	0	0	106	-	-	2	-	-
TSA/VRB	23	3.38	0.28	0	0	0	46	-	-	0	-	-
VRB	11	3.35	0.19	0	0	0	22	-	-	0	-	-
EC medium	10	3.18	0.45	0	0	0	18	-	-	2	-	-
Petrifilm™ EC/CC	5	3.12	0.14	0	0	0	10	-	-	0	-	-

A

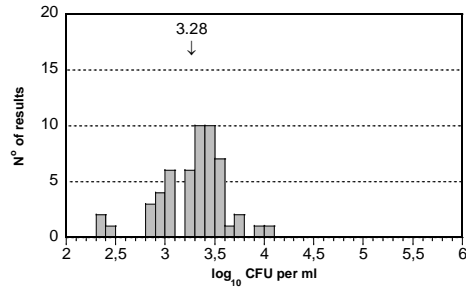

A

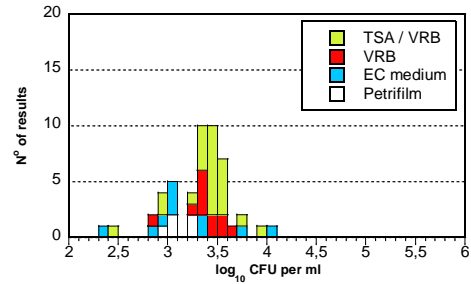

### Results of *E.coli* analysis

Medium	Mixture A						Mixture B/C					
	n	m	s	F	<	>	n	m	s	F	<	>
Total	117	3.13	0.25	0	6	1	232	-	-	7	-	-
Petrifilm™ EC/CC	24	3.10	0.17	0	3	0	48	-	-	2	-	-
Petrifilm™ SEC	21	3.17	0.10	0	2	0	42	-	-	2	-	-
TSA/VRB	22	3.25	0.30	0	0	0	44	-	-	0	-	-
TBX	15	3.01	0.13	0	0	0	30	-	-	1	-	-
VRB	10	3.19	0.34	0	0	0	20	-	-	0	-	-

A

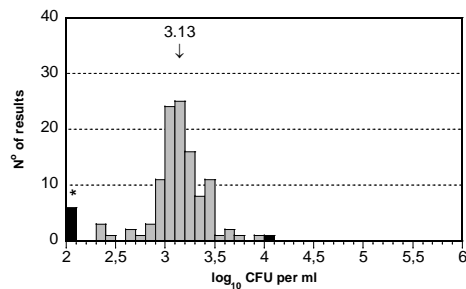

A

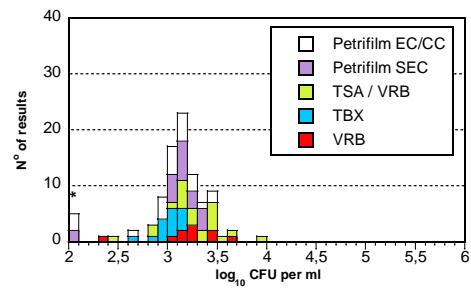

For the analysis of thermotolerant coliform bacteria, EC medium is used in MPN method. Depending on the producer growth of *K. pneumoniae* in EC medium is described as poor to very good. This can explain the lower mean value and the large spreading of the results reported by laboratories using this medium.

For the analysis of *E. coli*, there is no statistically significant difference between the reported results depending on the medium used. However it can be noticed that the use of chromogenic medium TBX led to lower results compared to the total average: 3.01 versus 3.13. On this medium which reveals the presence of  $\beta$ -glucuronidase activity, only colonies of *E. coli* appear typical and will therefore be counted (*K. pneumoniae* does not produce  $\beta$ -glucuronidase enzyme).

Results obtained with VRB (with or without TSA) are quite spread: on this medium *E. coli* and *K. pneumoniae* form typical colonies that could be all counted as *E. coli* if confirmation is not performed. If confirmation is performed the number of colonies counted as *E. coli* will depend on the proportion of *E. coli* and *K. pneumoniae* colonies tested.

## Presumptive *Bacillus cereus*

### Mixture A

Mixture A did not contain any target-organism for this analysis.

### Mixture B/C

A strain of *Bacillus cereus* was target organism for this analysis. On blood agar *P. alcalifaciens* formed large white colonies that made the reading of isolation plate difficult, explaining the spreading of results. The colonies of *P. alcalifaciens* were atypical without halo of haemolysis. Out of 122 laboratories that performed the analysis, 7 reported a false negative result for both mixture B and C.

### Results of presumptive *B. cereus* analysis

Method	Mixture A						Mixture B/C					
	n	m	s	F	<	>	n	m	s	F	<	>
Total	124	-	-	3	-	-	244	3.99	0.26	14	5	0
NMKL 67:2010	66	-	-	1	-	-	130	4.06	0.24	4	3	0
ISO 7932:2004	28	-	-	0	-	-	56	3.92	0.24	4	2	0

B/C

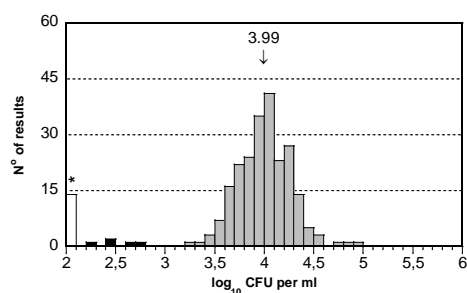

B/C

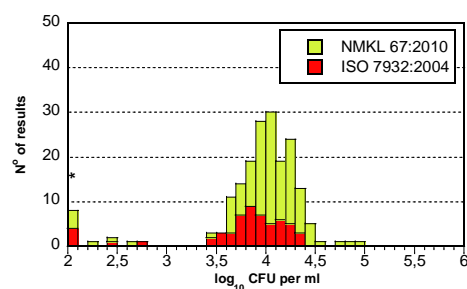

Laboratories that used the ISO method reported results with a slightly lower mean value than the one that used the NMKL method. The NMKL method 67:2010 describes an isolation on blood-agar plates followed by the confirmation of suspected colonies on BcS agar or Cereus-Ident-Agar (chromogenic medium) while the ISO method 7932:2004 describes first an isolation on MYP medium followed by a confirmation of suspected colonies on blood-agar. It is possible that the *B. cereus* strain had a slightly better recovery on blood-agar non-selective medium than on MYP selective medium leading to a higher number of colonies counted by the laboratories using the NMKL method.

## Coagulase-positive *Staphylococci*

### Mixture A

Mixture A did not contain any target-organism for this analysis.

### Mixture B/C

A strain of *Staphylococcus aureus* was target-organism for this analysis.

*Results of coagulase-positive Staphylococci analysis*

Medium	Mixture A						Mixture B/C					
	n	m	s	F	<	>	n	m	s	F	<	>
Total	111	-	-	6	-	-	224	3.80	0.13	4	8	3
BP	70	-	-	1	-	-	142	3.79	0.14	4	6	2
BP + RPF	18	-	-	0	-	-	36	3.84	0.09	0	0	0
Petrifilm Staph	18	-	-	4	-	-	36	3.78	0.12	0	2	0

B/C

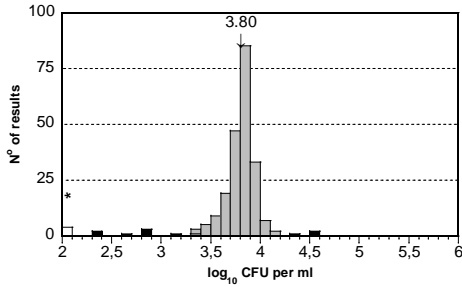

B/C

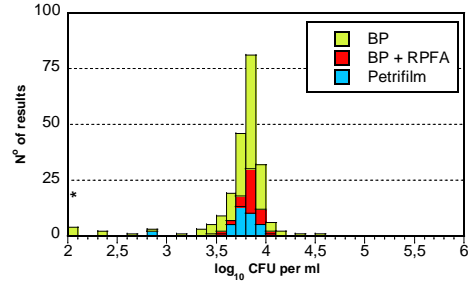

There are no significant differences in results depending on the medium chosen for the analysis of coagulase-positive staphylococci.

**Enterococci**

**Mixture A**

A strain of *Enterococcus faecium* was target-organism for this analysis.

**Mixture B/C**

Mixture B/C did not contain any target-organism for this analysis.

*Results of enterococci analysis*

Medium	Mixture A						Mixture B/C					
	n	m	s	F	<	>	n	m	s	F	<	>
Total	70	3.91	0.08	2	4	0	142	-	-	2	-	-
S&B	53	3.91	0.09	2	4	0	106	-	-	2	-	-
TSA/S&B	9	3.91	0.07	0	0	0	18	-	-	0	-	-

A

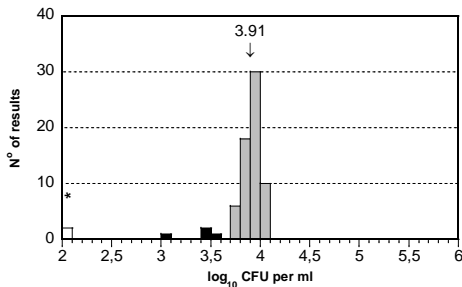

A

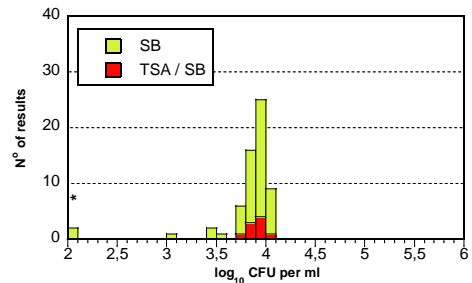

This analysis did not cause any difficulty to laboratories. Most of them used S&B medium with or without TSA and followed the method NMKL 68:2011. Few laboratories used the method IDF 149A:1997. There are no differences in results depending on the medium or method chosen for the analysis of enterococci.

## Gram-negative bacteria in pasteurized milk and cream. Detection of re-contamination

---

### Mixture A

Both *Escherichia coli* and *Klebsiella pneumoniae* were target-organisms for this analysis.

### Mixture B/C

*Providencia alcalifaciens* was target-organism for this analysis.

### Results of gram-negative bacteria in dairy products analysis

Method	Mixture A						Mixture B/C					
	n	m	s	F	<	>	n	m	s	F	<	>
Total	12	-	-	0	-	-	23	-	-	2	-	-
NMKL 192:2011	10	-	-	0	-	-	19	-	-	2	-	-

This analysis is qualitative and aims at identifying potential re-contamination in dairy products after pasteurization. Products to test should be incubated at room temperature for 28h or 25°C for 24h; thereafter 100µl or 10µl of sample are applied on VRBG plates, respectively. Re-contamination is identified when 5 or more colonies are counted and confirmed as from Gram-negative bacteria (if needed). In this round all mixtures contained target-organisms in high concentration and therefore identification of Gram-negative bacteria should not have caused any problem to the laboratories performing this analysis.



## **Outcome of the results of individual laboratory - assessment**

---

In order to allow comparison of the results from different analyses and mixtures, all the results of the analyses were transformed into standard values (z-scores). For quantitative analyses, a z-score is either positive or negative, depending on whether the individual result is higher or lower than the mean value calculated from all laboratory results for each analysis. For qualitative analyses, a z-score of zero is attributed for a correct answer. The z-scores obtained, which are listed in Annex 2, can be used as a tool by laboratories when following up on the results.

All the results from each laboratory – outliers included and false results excluded – were compiled into a box plot based on their z-scores. The smaller and more centred round zero the box of a laboratory is, the closer its results are to the general mean values calculated for all laboratory results.

The laboratories were not grouped or ranked based on their results. However, for each laboratory, the numbers of false results and outliers are presented below the box plots. These results are also highlighted in Annex 1, where all the reported results are listed, and the minimum and maximum accepted values for each analysis are stated.

Information on the results processing and recommendations for follow-up work are given in the Scheme Protocol (2). Samples for follow-up can be ordered, free of charge via our website: [www.livsmedelsverket.se/en/PT-extra](http://www.livsmedelsverket.se/en/PT-extra)

### **Box plots and numbers of deviating results for each laboratory**

- *The plots are based on the laboratory results from all analyses transformed into z-scores calculated according to the formula:  $z = (x-m)/s$ , where  $x$  is the result of the individual laboratory,  $m$  is the mean of the results of all participating laboratories, and  $s$  is the standard deviation.*
- *Correct results for quantitative analyses without target organism and for qualitative analyses generate a z-value of 0.*
- *The laboratory median value is illustrated by a horizontal red line in the box.*
- *The box includes 50 % of a laboratory's results (25 % of the results above the median and 25 % of the results below the median). The remaining 50 % are illustrated by lines and circles outside the box.*
- *Very deviating results are represented by circles and are calculated as follow:  
< [the lowest result in the box – 1.5 × (the highest result in the box – the lowest result in the box)]  
or  
> [ the highest result in the box + 1.5 × (the highest result in the box – the lowest result in the box)].*
- *z-scores higher than +4 and less than –4 are positioned at +4 and –4, respectively, in the plot.*
- *The background is divided by lines and shaded fields to indicate ranges in order to simplify location of laboratory results.*

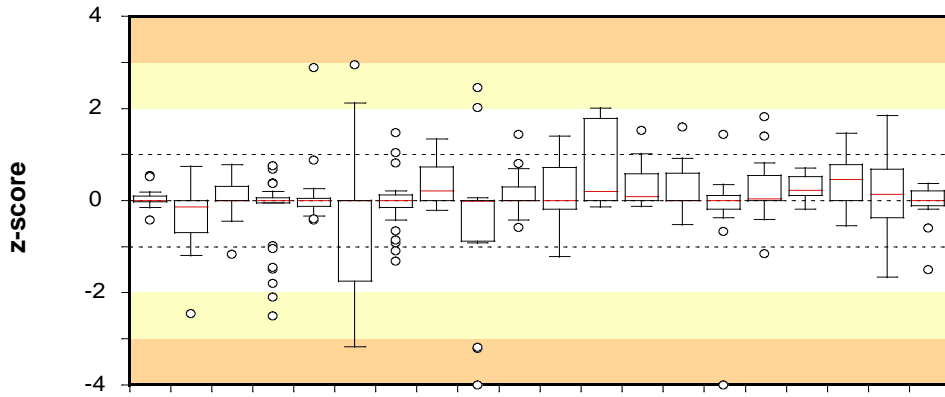

Lab no	1149	1254	1594	1970	2035	2058	2072	2221	2324	2386	2402	2459	2637	2659	2670	2704	2720	2745	2757	2764
No. of results	18	24	27	30	18	9	30	27	18	15	12	16	23	14	15	18	7	18	13	13
False positive	-	-	-	-	-	-	-	-	-	-	-	-	2	1	4	-	-	-	2	2
False negative	-	-	-	-	-	-	-	-	-	-	-	-	-	-	-	-	2	-	-	-
Low outliers	-	-	-	-	-	-	-	-	1	-	-	-	-	-	2	-	-	-	-	-
High outliers	-	-	-	-	-	-	-	-	-	-	-	-	-	-	-	-	-	-	-	-

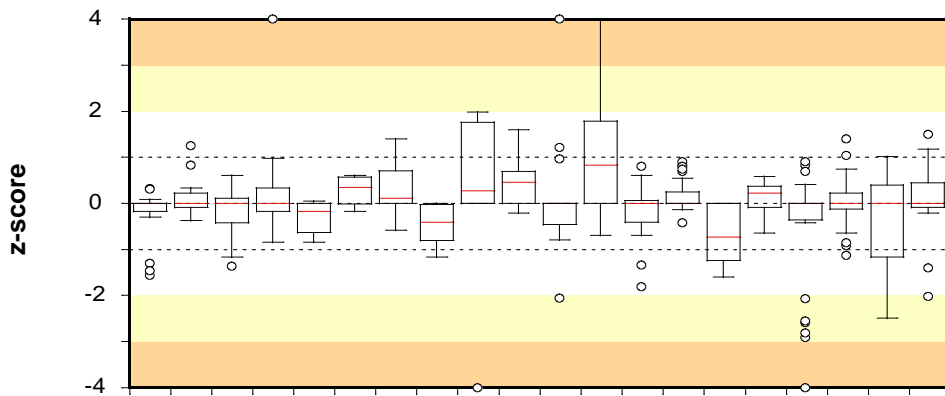

Lab no	2842	2941	3055	3159	3225	3243	3305	3327	3452	3457	3533	3543	3587	3626	3831	3864	3868	3923	3925	4047
No. of results	19	19	12	24	12	4	16	12	6	18	15	15	18	27	12	7	27	30	5	15
False positive	-	2	-	-	-	-	-	-	-	-	-	-	-	-	-	-	-	-	1	-
False negative	2	-	-	-	-	-	2	-	-	-	-	-	-	-	-	2	-	-	-	-
Low outliers	-	-	-	-	-	-	-	-	1	-	-	-	-	-	-	-	1	-	-	-
High outliers	-	-	-	1	-	-	-	-	-	-	1	3	-	-	-	-	-	-	-	-

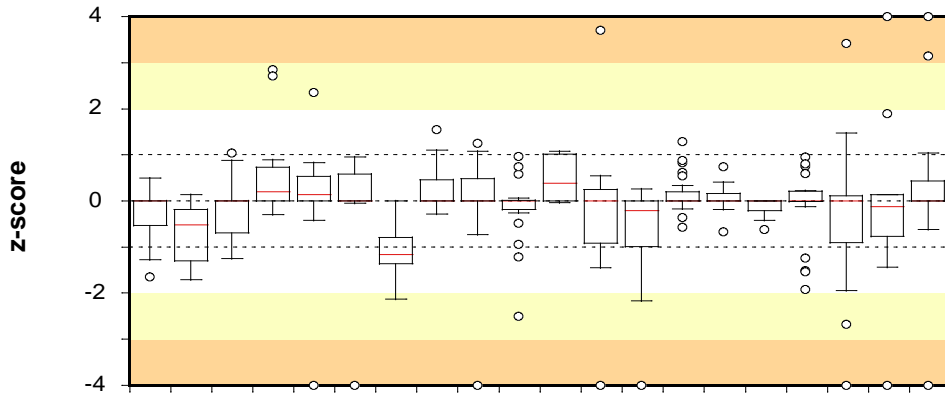

Lab no	4050	4064	4100	4171	4246	4266	4278	4288	4339	4352	4400	4538	4562	4633	4635	4664	4683	4840	4879	4889
No. of results	18	6	21	13	16	9	9	27	27	21	9	11	21	27	14	8	24	18	9	27
False positive	-	-	-	2	-	-	-	-	-	3	-	2	-	-	-	-	-	-	3	-
False negative	-	-	-	-	2	-	-	-	-	-	-	-	-	-	1	-	-	-	-	-
Low outliers	-	-	-	-	2	1	-	-	1	-	-	1	1	-	-	-	-	2	1	1
High outliers	-	-	-	-	-	-	-	-	-	-	-	1	-	-	-	-	-	-	1	1

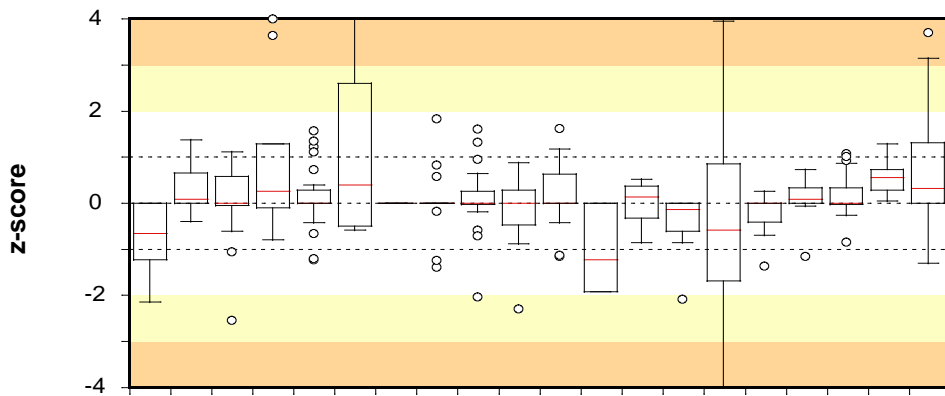

Lab no	4951	4955	4980	4998	5018	5100	5119	5162	5200	5201	5204	5220	5221	5250	5290	5304	5329	5333	5338	5352
No. of results	12	18	18	9	27	4	-	14	24	18	24	6	6	8	13	7	21	24	6	22
False positive	-	-	-	-	-	2	-	-	-	-	-	-	-	2	8	2	-	-	-	2
False negative	-	-	-	-	-	-	-	1	-	-	-	-	-	2	-	-	-	-	-	-
Low outliers	-	-	-	-	-	-	-	-	-	-	-	-	-	-	2	-	-	-	-	-
High outliers	-	-	-	1	-	1	-	-	-	-	-	-	-	-	1	-	-	-	-	1

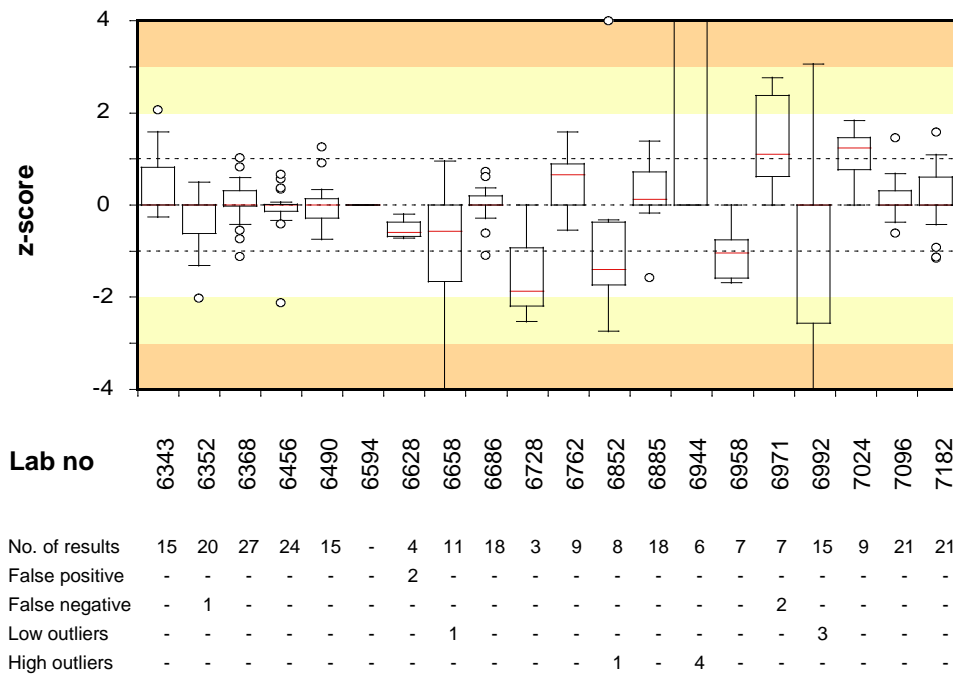
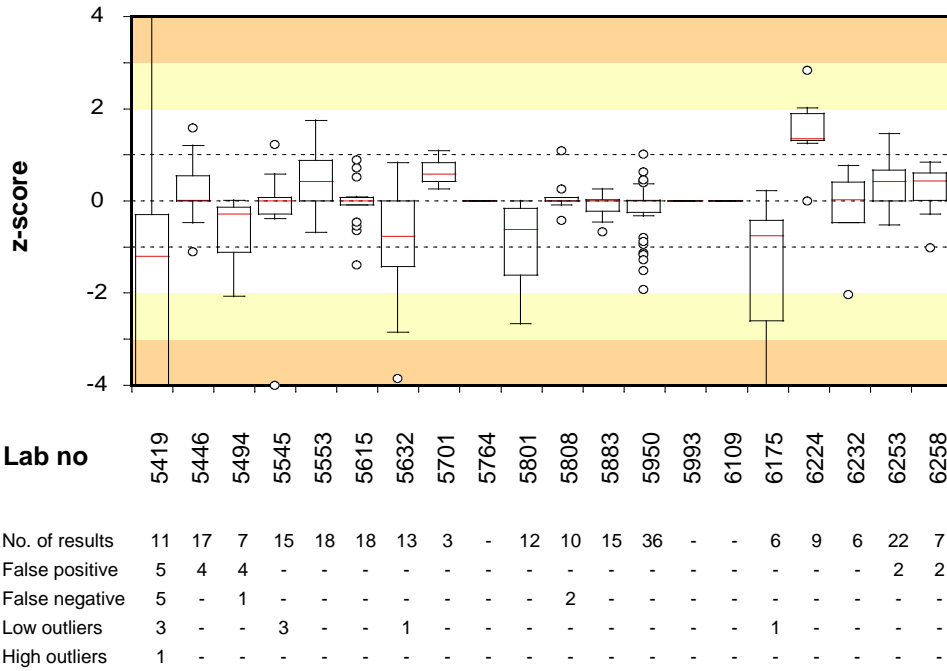

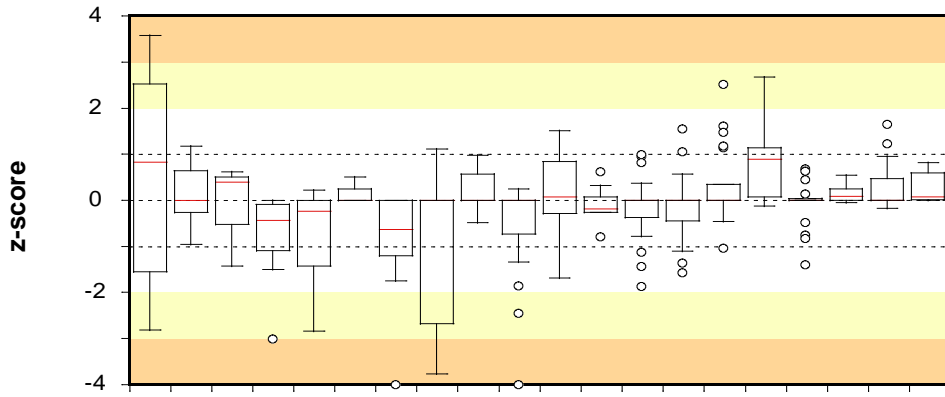

Lab no	7191	7207	7232	7242	7248	7253	7334	7543	7564	7596	7627	7631	7640	7688	7728	7750	7825	7876	7930	7940
No. of results	11	12	3	8	24	9	13	21	21	25	7	7	30	27	21	10	17	16	27	5
False positive	8	-	-	-	-	-	2	-	-	-	2	2	-	-	-	2	-	-	-	1
False negative	2	-	-	1	-	-	-	-	-	2	-	-	-	-	-	-	1	2	-	-
Low outliers	-	-	-	-	-	-	1	-	-	1	-	-	-	-	-	-	-	-	-	-
High outliers	1	-	-	-	-	-	-	-	-	-	-	-	-	-	-	-	-	-	-	-

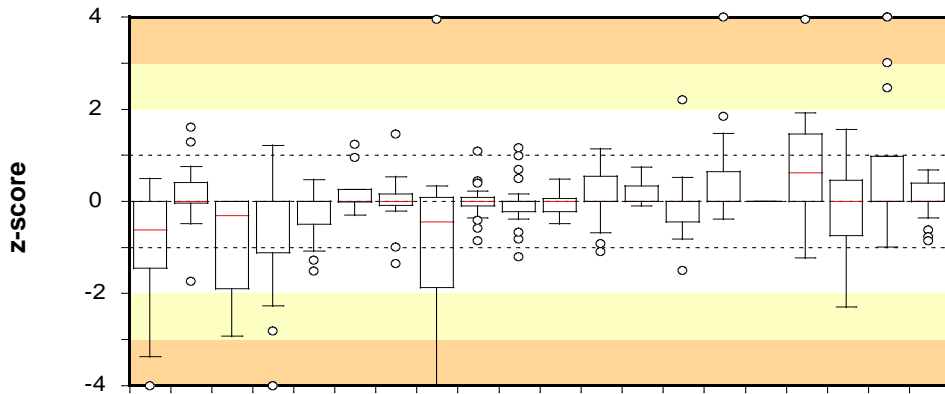

Lab no	7962	7968	7984	8066	8068	8105	8213	8228	8260	8313	8333	8397	8417	8430	8435	8523	8529	8568	8626	8628
No. of results	23	30	12	21	29	10	15	13	24	21	15	18	18	14	30	-	21	13	18	30
False positive	4	-	-	-	1	2	-	2	-	-	-	-	-	1	-	-	-	2	-	-
False negative	-	-	-	-	-	-	-	-	-	-	-	-	-	-	-	-	-	-	-	-
Low outliers	1	-	-	3	-	-	-	2	-	-	-	-	-	-	-	-	-	-	-	-
High outliers	-	-	-	-	-	-	-	1	-	-	-	-	-	-	1	-	1	-	2	-

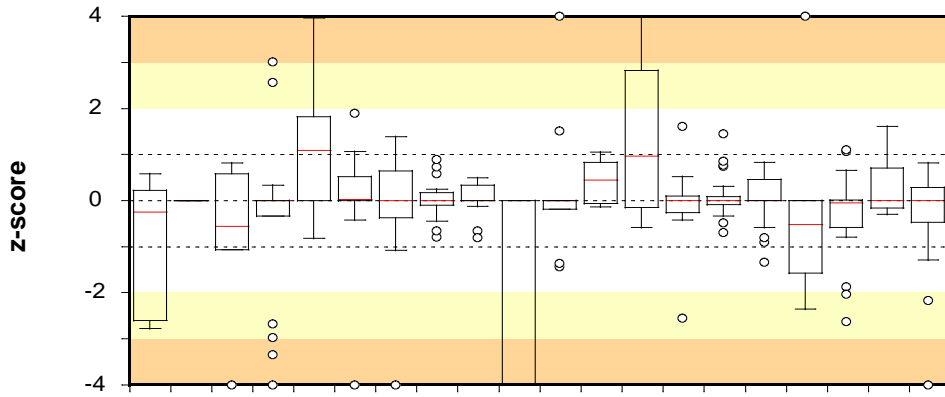

Lab no	8657	8696	8734	8742	8756	8766	8891	8909	8918	9007	9025	9034	9078	9217	9408	9429	9436	9453	9512	9559
No. of results	6	-	6	21	17	18	20	19	18	14	9	12	4	11	23	30	27	18	9	25
False positive	-	-	-	-	1	-	-	2	-	1	-	-	2	1	1	-	-	-	-	2
False negative	-	-	-	-	-	-	1	-	-	-	-	-	-	-	-	-	-	-	-	-
Low outliers	-	-	1	2	-	1	1	-	-	10	-	-	-	-	-	-	-	-	-	1
High outliers	-	-	-	-	1	-	-	-	-	-	1	-	1	-	-	-	1	-	-	-

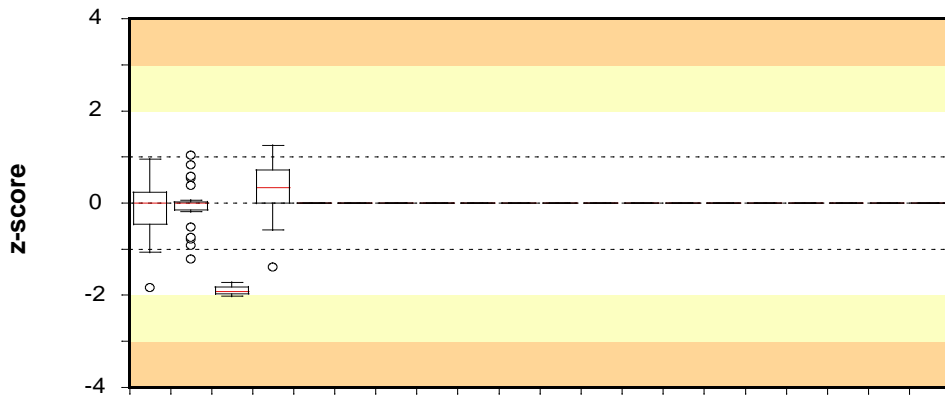

Lab no	9655	9662	9747	9890	9903	9950
No. of results	18	24	3	21	-	-
False positive	-	-	-	-	-	-
False negative	-	-	-	-	-	-
Low outliers	-	-	-	-	-	-
High outliers	-	-	-	-	-	-

## Test material and quality control

### Test material

Each laboratory received three freeze-dried microbial mixtures designated A-C. The manufactured test material was freeze-dried in portions of 0.5 ml in vials, as described by Peterz and Steneryd (3). Before analysing the samples, the contents of each vial had to be dissolved in 254 ml of diluent. The organisms present in the mixtures are listed in Table 2.

**Table 2.** *Microorganisms present in mixture A-C supplied to participants*

Mixture <sup>1</sup>	Microorganism	Strain no.
A	<i>Klebsiella pneumoniae</i>	SLV-186 / CCUG 45102
	<i>Escherichia coli</i>	SLV-165 / CCUG 43600
	<i>Enterococcus faecium</i>	SLV-459 / CCUG 35172
B	<i>Providencia alcalifaciens</i>	SLV-045 / CCUG 44809
	<i>Staphylococcus aureus</i>	SLV-350 / CCUG 45099
	<i>Bacillus cereus</i>	SLV-160 / CCUG 45098
C	<i>Providencia alcalifaciens</i>	SLV-045 / CCUG 44809
	<i>Staphylococcus aureus</i>	SLV-350 / CCUG 45099
	<i>Bacillus cereus</i>	SLV-160 / CCUG 45098

<sup>1</sup>The links between the mixtures and the randomised sample numbers are shown in annex 1

### Quality control of the mixtures

It is essential to have aliquots of homogeneous mixture and equal volume in all vials in order to allow comparison of all freeze-dried samples from one mixture. Quality control is performed on 10 randomly chosen vials in conjunction with manufacturing of the mixtures or on 5 vials if an “old” mixture was used and the last quality control was performed more than 6 months ago. Homogeneity of a mixture is approved if, for each analysis, the values obtained for the test of reproducibility (T) and the test “Index of dispersion” between vials ( $I_2$ ) do not exceed simultaneously 2.6 and 2.0, respectively.

**Table 3.** Concentration mean ( $m$ ),  $T$  and  $I_2$  values from the quality control of the mixtures;  $m$  is expressed in  $\log_{10}$  cfu (colony forming units) per ml of sample.

Analysis and method	A			B/C		
	$m$	T	$I_2$	$m$	T	$I_2$
Aerobic microorganisms 30°C NMKL-method no. 86	4.08	1.16	0.35	4.89	1.28	1.19
Aerobic microorganisms 20°C NMKL-method no. 86	4.06	1.24	0.65	4.87	1.36	1.67
Contaminating microorganisms ISO-method no. 13559:2002 IDF-method no. 153:2002	4.08	1.14	0.25	5.02	1.23	1.15
Enterobacteriaceae NMKL-method nr. 144	3.49	1.67	1.93	4.95	1.34	1.95
Coliform bacteria 30°C NMKL-method no. 44	3.39	1.56	1.25	-	-	-
Coliform bacteria. 37°C NMKL-method no. 44	3.43	1.79	2.59	-	-	-
Thermotolerant coliform bacteria NMKL-method no. 125	3.53	1.71	2.32	-	-	-
<i>Escherichia coli</i> NMKL-method no. 125	3.25*	1.28	0.29	-	-	-
Presumptive <i>Bacillus cereus</i> NMKL-method no. 67	-	-	-	4.33	1.18	0.15
Coagulase-positive <i>Staphylococci</i> NMKL-method no. 66	-	-	-	3.89	1.14	0.34
<i>Enterococci</i> NMKL-method no. 68	3.90	1.24	0.92	-	-	-
Gram-negative bacteria in pasteurized milk and cream. Detection of recontamination NMKL-method no. 192	pos	-	-	pos	-	-

- No target organism

\* colonies counted on Petrifilm™ SEC



## References

1. Kelly, K. 1990. Outlier detection in collaborative studies. *J. Assoc. Off. Anal. Chem.* 73:58-64.
2. Anonymous, 2012. Protocol. Microbiology. Drinking Water & Food. The National Food Agency.
3. Peterz. M. Steneryd. A.C. 1993. Freeze-dried mixed cultures as reference samples in quantitative and qualitative microbiological examinations of food. *J. Appl. Bacteriol.* 74:143-148.

**Annex 1**

**Results from the participating laboratories - October 2015**

All results are expressed in log<sub>10</sub> cfu per ml sample.

Results reported as "<value" have been regarded as zero (negative). Results regarded as "> value" are excluded in the calculations.

A dash in the table indicates that the analysis was not performed.

Outliers and false results are highlighted and summarized for each analysis in the end of the table.

**Mixture B och C:** median, mean value (m), standard deviation (s) and amount of deviating results (F+, F-, <, >) were calculated from the results of each mixture while the interval limits (<OK, >OK) were calculated from all results from both mixtures.

Lab no	Code no	Aerobic microorg. 30 °C			Aerobic microorg. 20 °C			Contaminating microorg. In milk products			Enterobacteriaceae			Coliform bacteria 30 °C			Coliform bacteria 37 °C			Thermotolerant coliform bacteria			Escherichia coli			Presumptive Bacillus cereus			Coagulase-positive staphylococci			Enterococci			Gram-neg bacteria in dairy prod.			Lab no			
		A	B	C	A	B	C	A	B	C	A	B	C	A	B	C	A	B	C	A	B	C	A	B	C	A	B	C	A	B	C	A	B	C							
1149	1 2 3	4	5	5	-	-	-	-	-	-	3.36	4.78	4.78	-	-	-	3.36	<1	<1	-	-	-	3.18	<1	<1	<2	4	4	<1	3.81	3.81	-	-	-	-	-	-	1149			
1254	1 2 3	4	4.74	4.75	3.98	4.72	4.83	-	-	-	3.26	4.48	4.69	3.26	<1	<1	-	-	-	3.22	<1	<1	2.84	<1	<1	<1	4.04	3.98	<1	3.77	3.9	-	-	-	-	-	-	1254			
1594	2 3 1	3.94	4.95	5.04	-	-	-	-	-	-	3.34	4.84	4.81	3.19	<1	<1	3.38	<1	<1	3.5	<1	<1	3.2	<1	<1	<2	4.11	4.15	<1	3.85	3.82	3.94	<1	<1	-	-	-	-	1594		
1970	3 1 2	4.03	4.65	4.69	3.91	4.69	4.88	-	-	-	3.46	4.66	4.79	3.48	<1	<1	3.51	<1	<1	3.53	<1	<1	3.14	<1	<1	<2	4.02	4.02	<1	3.48	3.51	3.94	<1	<1	-	-	-	-	1970		
2035	2 3 1	4	4.9	4.9	-	-	-	-	-	-	3.4	4.8	4.9	4	<1	<1	-	-	-	-	-	-	3.2	<1	<1	<2	3.9	3.9	<1	3.8	3.8	-	-	-	-	-	-	2035			
2058	1 2 3	3.78	4.61	4.65	-	-	-	-	-	-	-	-	-	-	-	-	-	-	-	-	-	-	3.1	0	0	0	4.7	4.59	-	-	-	-	-	-	-	-	-	-	2058		
2072	1 2 3	3.96	4.94	5.08	3.98	4.89	5	-	-	-	3.36	4.82	4.98	3.3	<1	<1	3.36	<1	<1	3.3	<1	<1	3.08	<1	<1	<1	3.82	3.71	<1	3.63	3.68	3.92	<1	<1	-	-	-	-	2072		
2221	1 3 2	4.14	4.98	5.07	-	-	-	4.09	4.97	4.96	3.35	4.92	4.89	3.35	<3	<3	3.35	<3	<3	-	-	-	3.15	<1	<1	<2	4.3	4.29	<1	3.84	3.87	3.98	<1	<1	-	-	-	-	2221		
2324	2 1 3	4.01	4.78	4.9	-	-	-	-	-	-	3.31	4.79	4.79	-	-	-	-	-	-	-	-	-	2.91	0	0	0	4.58	4.56	0	3.39	3.36	3.55	0	0	-	-	-	-	2324		
2386	1 3 2	4	4.94	5.14	-	-	-	-	-	-	-	-	-	-	-	-	3.3	<1	<1	3.08	<1	<1	-	-	-	<1	4	4.2	<1	3.9	3.86	-	-	-	-	-	-	-	2386		
2402	1 3 2	4.1	5.05	5.01	-	-	-	-	-	-	3.65	4.64	4.62	-	-	-	3.43	<1	<1	-	-	-	3.04	<1	<1	-	-	-	-	-	-	-	-	-	-	-	-	-	2402		
2459	2 3 1	4.18	5.11	5.2	4.15	5.17	5.23	-	-	-	-	-	-	-	-	-	3.35	<1	<1	-	-	-	3.22	<1	<1	<1	<1	<1	<1	3.78	3.84	-	-	-	-	-	-	-	2459		
2637	1 3 2	4.04	4.9	5	-	-	-	<1	4.91	5.04	3.41	4.79	4.87	-	-	-	3.45	<1	<1	3.52	<1	<1	3.52	<1	<1	<1	4.23	4.2	<1	3.81	3.81	-	-	-	-	-	-	-	2637		
2659	3 2 1	4.04	5.03	5.06	-	-	-	-	-	-	-	-	-	3.3	4.87	5.1	3.18	4.78	4.92	-	-	-	3	<1	<1	-	-	-	<1	4	3.88	-	-	-	-	-	-	-	2659		
2670	2 1 3	3.98	4.97	5.14	-	-	-	-	-	-	-	-	-	-	-	-	3.38	0	0	3.38	0	0	3.04	0	0	0	2.62	2.89	-	-	-	-	-	-	-	-	-	-	2670		
2704	1 2 3	4.04	5.04	5.2	-	-	-	-	-	-	3.49	4.74	4.83	-	-	-	3.51	<1	<1	-	-	-	3.11	<1	<1	<2	3.7	4.08	<1	3.81	3.99	-	-	-	-	-	-	-	2704		
2720	2 1 3	4.09	4.95	4.89	-	-	-	-	-	-	3.43	4.88	4.83	-	-	-	-	-	-	-	-	-	-	-	-	<1	<1	<1	-	-	-	-	-	-	-	-	-	-	-	2720	
2745	1 3 2	3.99	5	5	-	-	-	-	-	-	3.46	4.97	4.92	-	-	-	-	-	-	3.54	<1	<1	3.32	<1	<1	<2	4.3	4.41	<1	3.89	3.8	-	-	-	-	-	-	-	-	2745	
2757	3 1 2	4.08	5.04	4.94	4.04	5.18	5	-	-	-	3.32	4.88	4.56	3.26	4.74	4.7	-	-	-	-	-	-	<2	3.87	3.85	-	-	-	-	-	-	-	-	-	-	-	-	-	2757		
2764	1 3 2	4.05	4.95	4.92	-	-	-	-	-	-	3.11	4.77	4.77	-	-	-	3.15	4.58	4.59	-	-	-	<1	4.03	3.98	-	-	-	-	-	3.94	<2	<2	-	-	-	-	-	-	2764	
2842	2 3 1	3.93	4.93	4.9	-	-	-	-	-	-	3.45	<1	<1	3.28	<1	<1	-	-	-	3.28	<1	<1	3.08	<1	<1	<1	3.6	3.61	<1	3.76	3.84	-	-	-	-	-	-	-	-	2842	
2941	2 1 3	4.06	4.91	4.95	-	-	-	-	-	-	3.32	4.9	4.95	3.25	4.69	4.7	-	-	-	-	-	-	3.2	<1	<1	<1	3.98	3.95	<1	3.83	3.76	3.9	<1	<1	-	-	-	-	-	2941	
3055	2 3 1	3.94	4.83	4.71	-	-	-	-	-	-	3.42	4.76	4.79	-	-	-	-	-	-	-	-	-	0	4.13	4.06	-	4.13	4.06	-	-	-	-	-	-	-	-	-	-	-	3055	
3159	1 2 3	4.08	4.93	5.07	3.98	4.99	4.94	-	-	-	3.32	4.69	4.84	-	-	-	3.28	<1	<1	3.26	<1	<1	3.08	<1	<1	<1	4.04	3.78	<1	3.74	4.57	-	-	-	-	-	-	-	3159		
3225	3 1 2	4.01	4.91	4.8	-	-	-	-	-	-	3.24	4.8	4.67	-	-	-	-	-	-	-	-	-	-	-	-	<1	3.86	3.93	-	-	-	-	-	-	-	-	-	-	-	3225	
3243	3 1 2	4.02	4.94	-	-	-	-	-	-	-	3.49	4.87	-	-	-	-	-	-	-	-	-	-	-	-	-	-	-	-	-	-	-	-	-	-	-	-	-	-	-	3243	
3305	3 2 1	4.11	4.95	4.98	-	-	-	-	-	-	3.28	4.88	4.97	-	-	-	-	-	-	3.52	<1	<1	3.41	<1	<1	<2	<2	<2	<1	3.74	3.86	-	-	-	-	-	-	-	-	3305	
3327	3 2 1	3.96	4.75	4.74	-	-	-	-	-	-	3.38	4.75	4.76	-	-	-	-	-	-	-	-	-	3.01	0	0	-	0	3.71	3.72	-	-	-	-	-	-	-	-	-	-	-	3327
3452	1 2 3	3.46	5	5.19	-	-	-	-	-	-	-	-	-	3.78	<1	<1	-	-	-	-	-	-	-	-	-	-	-	-	-	-	-	-	-	-	-	-	-	-	-	3452	
3457	2 1 3	-	-	-	4.08	4.98	5.04	-	-	-	3.56	4.86	4.87	-	-	-	3.48	<1	<1	3.43	<1	<1	-	-	-	<1	3.77	3.86	4.04	<1	<1	-	-	-	-	-	-	-	-	-	3457
3533	2 1 3	4	4.61	4.81	-	-	-	-	-	-	-	-	-	-	-	-	3.66	<1	<1	3.01	<1	<1	3.01	<1	<1	-	-	-	<1	4.56	3.93	-	-	-	-	-	-	-	-	3533	
3543	3 2 1	5	6.11	6.17	-	-	-	-	-	-	3.26	4.9	4.78	-	-	-	-	-	-	-	-	-	<2	4.31	4.32	<1	3.97	3.86	4.09	<1	<1	-	-	-	-	-	-	-	-	3543	
3587	3 2 1	3.98	4.9	4.93	-	-	-	-	-	-	3.3	4.74	4.78	-	-	-	-	-	-	-	-	-	3.2	<1	<1	<2	4.18	4.18	<1	3.57	3.613	3.95	<1	<1	-	-	-	-	-	3587	
3626	1 2 3	4	5	4.9	-	-	-	-	-	-	3.4	4.9	4.8	3.3	<3	<3	3.3	<3	<3	3.4	<1	<1	3.1	<1	<1	<2	4.2	4.2	<1	3.9	3.9	3.9	<1	<1	-	-	-	-	-	3626	
3831	1 3 2	3.93	4.81	4.73	3.9	4.73	4.6	-	-	-	-	-	-	-	-	-	3.24	0	0	-	-	-	2.9	0	0	-	-	-	-	-	-	-	-	-	-	-	-	-	-	3831	
m		4.033	4.917	4.919	4.009	4.860	4.842	3.778	4.765	4.689	3.389	4.793	4.782	3.298	0	0	3.317	0	0	3.277	0	0	3.133	0	0	0	3.980	4.009	0	3.797	3.797	3.909	0	0	pos	pos	pos	m			
s		0.080	0.149	0.154	0.068	0.174	0.193	0.463	0.398	0.504	0.187	0.128	0.134	0.243	0	0	0.280	0	0	0.335	0	0	0.253	0	0	0	0.244	0.273	0	0.127	0.138	0.082	0	0	-	-	-	s			

Lab no	Code no			Aerobic microorg. 30 °C			Aerobic microorg. 20 °C			Contaminating microorg. In milk products			Enterobacteriaceae			Coliform bacteria 30 °C			Coliform bacteria 37 °C			Thermotolerant coliform bacteria			Escherichia coli			Presumptive Bacillus cereus			Coagulase-positive staphylococci			Enterococci			Gram-neg bacteria in dairy prod.			Lab no
	A	B	C	A	B	C	A	B	C	A	B	C	A	B	C	A	B	C	A	B	C	A	B	C	A	B	C	A	B	C	A	B	C	A	B	C	A	B	C	
3864	3	2	1	4.1	4.95	5	-	-	-	-	-	-	3.4	4.71	4.8	-	-	-	-	-	-	-	-	-	-	-	-	-	-	-	-	-	-	-	Pos	Neg	Neg	3864		
3868	2	1	3	4.01	4.89	4.88	-	-	-	-	-	-	2.49	4.9	4.81	2.59	<1	<1	2.59	<1	<1	2.42	<1	<1	2.42	<1	<1	<2	4.2	4.2	<1	3.85	3.74	3.74	<1	<1	-	-	-	3868
3923	3	1	2	4	4.98	4.9	4.04	4.92	4.84	-	-	-	3.28	4.8	4.71	3.38	<1	<1	3.38	<1	<1	2.97	<1	<1	2.97	<1	<1	<1	3.77	3.7	<1	3.93	3.99	3.97	<1	<1	-	-	-	3923
3925	1	3	2	3.94	5.07	4.98	-	-	-	-	-	-	-	-	-	-	-	-	-	-	-	-	-	-	-	-	-	-	-	-	-	-	-	-	-	-	-	3925		
4047	3	2	1	4.02	5.09	5.15	-	-	-	-	-	-	3.35	4.86	4.94	-	-	-	-	-	-	-	-	-	3.13	<1	<1	<1	4.01	4.11	<1	3.62	3.52	-	-	-	-	-	4047	
4050	3	2	1	4.01	4.85	4.92	-	-	-	3.53	4.84	4.94	3.08	4.85	4.74	3.09	<1	<1	-	-	-	-	-	-	-	-	<1	3.85	3.66	-	-	-	-	-	-	Pos	Pos	Pos	4050	
4064	3	1	2	3.93	4.82	4.86	-	-	-	-	-	-	3.07	4.77	4.8	-	-	-	-	-	-	-	-	-	-	-	-	-	-	-	-	-	-	-	-	-	4064			
4100	3	1	2	3.99	4.73	4.86	-	-	-	-	-	-	3.26	4.66	4.69	-	-	-	3.26	<1	<1	-	-	-	2.99	<1	<1	<1	3.75	3.78	<1	3.91	3.94	3.98	<1	<1	-	-	-	4100
4171	2	3	1	4.01	5.05	4.95	-	-	-	-	-	-	3.92	4.85	4.88	-	-	-	4.08	5.06	4.83	-	-	-	-	-	<1	4.02	4.05	-	-	-	3.95	<2	<2	-	-	-	4171	
4246	2	3	1	4.1	5.01	4.99	4.17	4.97	4.9	-	-	-	3.31	0	0	-	-	-	3.4	0	0	-	-	-	3.2	0	0	0	2.3	2.32	-	-	-	-	-	-	-	4246		
4266	2	1	3	4.08	5.06	5	-	-	-	-	-	-	-	-	-	-	-	-	-	-	-	-	-	1.18	<1	<1	-	-	-	<1	3.89	3.79	-	-	-	-	-	-	4266	
4278	2	1	3	3.97	4.71	4.71	-	-	-	-	-	-	3.24	4.52	4.61	-	-	-	-	-	-	-	-	-	-	-	<1	3.71	3.69	-	-	-	-	-	-	-	-	4278		
4288	2	1	3	4.04	4.9	4.9	-	-	-	4.03	4.99	4.95	3.43	4.85	4.84	-	-	-	3.45	<1	<1	3.31	<1	<1	3.06	<1	<1	<2	3.95	4.11	<1	3.9	4.01	4	<1	<1	-	-	-	4288
4339	1	3	2	4.07	5.02	1.85	-	-	-	-	-	-	3.54	4.79	4.77	3.56	<1	<1	3.34	<1	<1	3.45	<1	<1	3.45	<1	<1	<2	3.97	3.88	<1	3.89	3.91	3.85	<1	<1	-	-	-	4339
4352	3	1	2	-	-	-	-	-	-	3.34	5.15	4.7	3.3	4.76	4.76	3.3	4.93	4.6	3.48	<1	<1	-	-	-	3.15	<1	<1	<2	3.95	3.96	2.5	3.48	3.9	3.81	<2	<2	-	-	-	4352
4400	2	3	1	4.12	4.97	5.04	-	-	-	-	-	-	3.46	4.79	4.92	-	-	-	-	-	-	-	-	-	-	<1	4.23	4	-	-	-	-	-	-	-	-	-	-	4400	
4538	2	1	3	3.25	4.7	4.77	-	-	-	-	-	-	3.49	<1	<1	4.2	4.91	4.9	-	-	-	-	-	-	3.08	<1	<1	<1	3.86	3.68	-	-	-	-	-	-	-	-	4538	
4562	1	2	3	3.67	4.69	4.65	-	-	-	-	-	-	3.34	4.69	4.65	-	-	-	3.36	<1	<1	-	-	-	3.08	<1	<1	<1	3.45	3.57	<1	3.83	3.76	3.85	<1	<1	-	-	-	4562
4633	2	1	3	4.02	5.01	4.97	-	-	-	-	-	-	3.43	4.9	4.9	3.33	<2	<2	3.37	<2	<2	3.46	<1	<1	3.46	<1	<1	<2	3.84	4.02	<1	3.8	3.81	3.88	<1	<1	-	-	-	4633
4635	3	2	1	3.98	4.9	4.92	-	-	-	-	-	-	3.42	4.77	4.79	-	-	-	-	-	-	-	-	-	<1	4.08	<1	<1	3.85	3.8	3.97	<1	<1	-	-	-	-	-	-	4635
4664	2	1	3	-	-	-	-	-	-	-	-	-	-	-	-	-	-	-	3.2	<1	<1	3.07	<1	<1	-	-	-	-	-	-	-	-	<1	<1	-	-	-	-	4664	
4683	2	3	1	4.11	4.9	4.95	-	-	-	-	-	-	3.43	4.79	4.58	3.32	<1	<1	3.53	<1	<1	3.53	<1	<1	2.82	<1	<1	<1	3.51	3.59	<1	3.9	3.88	-	-	-	-	-	4683	
4840	2	3	1	3.82	5.11	4.78	-	-	-	-	-	-	3.41	5.23	4.98	-	-	-	-	-	-	-	-	-	2.64	<1	<1	<1	2.77	2.47	<1	3.85	3.79	3.91	<1	<1	-	-	-	4840
4879	1	3	2	5.2	5.2	4.9	-	-	-	-	-	-	3.4	4.7	4.8	-	-	-	-	-	-	-	-	-	1.4	1.6	1.6	-	-	-	3.6	3.7	3.6	-	-	-	-	-	4879	
4889	3	1	2	4.87	4.93	4.04	4.08	4.89	4.83	-	-	-	3.41	4.87	4.7	-	-	-	3.3	0	0	3.34	0	0	3.26	0	0	0	3.98	4.87	0	3.89	3.9	3.94	0	0	-	-	-	4889
4951	3	2	1	3.95	4.76	4.59	-	-	-	-	-	-	3.34	4.53	4.64	-	-	-	2.93	<1	<1	-	-	-	3.07	<1	<1	-	-	-	-	-	-	-	-	-	-	-	4951	
4955	3	1	2	4.08	5.08	5.05	-	-	-	-	-	-	3.48	4.97	4.93	-	-	-	3.43	<1	<1	-	-	-	3.3	<1	<1	<2	4	3.9	<1	3.81	3.76	-	-	-	-	-	4955	
4980	3	1	2	4.08	5.01	5.07	-	-	-	-	-	-	3.38	4.72	4.82	-	-	-	3.38	<1	<1	-	-	-	3.28	<1	<1	<2	3.36	3.72	<1	3.72	3.95	-	-	-	-	-	4980	
4998	3	2	1	3.97	5.11	4.96	-	-	-	-	-	-	3.37	5.37	5.27	-	-	-	-	-	-	-	-	-	0	4.06	3.94	-	-	-	-	-	-	-	-	-	-	-	-	4998
5018	3	1	2	4	4.82	4.98	-	-	-	-	-	-	3.16	4.64	4.81	3.23	<1	<1	3.23	<1	<1	3.4	<1	<1	3.18	<1	<1	<1	4.28	4.44	<1	3.89	3.95	4.02	<1	<1	-	-	-	5018
5100	3	1	2	4.13	5.65	4.83	-	-	-	-	-	-	-	-	-	-	-	-	3.2	4.63	4.72	-	-	-	-	-	-	-	-	-	-	-	-	-	-	-	-	-	5100	
5119	1	3	2	-	-	-	-	-	-	-	-	-	-	-	-	-	-	-	-	-	-	-	-	-	-	-	-	-	-	-	-	-	-	-	-	-	-	-	-	5119
5162	2	1	3	4.08	4.71	4.73	-	-	-	-	-	-	-	-	-	<1	<1	<1	3.55	<1	<1	-	-	-	3.09	<1	<1	-	-	-	-	-	-	4.06	<1	<1	-	-	-	5162
5200	1	2	3	4.04	4.89	4.83	4.1	4.94	4.83	-	-	-	3.47	5	4.51	3.53	<1	<1	3.5	<1	<1	3.04	<0.48	<0.48	3.09	<1	<1	-	-	-	<1	3.81	3.8	-	-	-	-	-	5200	
5201	1	3	2	4.01	4.96	4.95	-	-	-	-	-	-	3.3	4.5	4.72	-	-	-	3.17	<1	<1	-	-	-	2.91	<1	<1	<2	4.12	4.25	<1	3.88	3.91	-	-	-	-	-	5201	
5204	1	3	2	4	5	5.1	-	-	-	-	-	-	3.5	4.8	5	-	-	-	3.6	<1	<1	3.5	<1	<1	3.1	<1	<1	<1	3.7	3.7	<2	3.9	3.8	4	<1	<1	-	-	-	5204
5220	2	3	1	3.88	4.63	4.66	-	-	-	-	-	-	-	-	-	-	-	-	-	-	-	-	-	2.94	0	0	-	-	-	-	-	-	-	-	-	-	-	-	-	5220
5221	1	2	3	4.05	4.79	4.87	-	-	-	4.02	4.79	4.88	-	-	-	-	-	-	-	-	-	-	-	-	-	-	-	-	-	-	-	-	-	-	-	-	-	-	-	5221
5250	3	2	1	-	-	-	-	-	-	-	-	-	3	4.79	4.75	-	-	-	3.08	4.79	4.88	-	-	-	3.04	<1	<1	<1	<1	<1	<1	-	-	-	-	-	-	-	-	5250
5290	2	3	1	4.15	1.94	4.57	-	-	-	-	-	-	3.99	4.84	5.31	2.89	4.62	4.6	2.92	4.7	4.59	-	-	-	0.9	9	0.9	1.9	4.19	4.11	2.9	3.72	3.6	-	-	-	-	-	-	5290
5304	3	1	2	-	-	-	-	-	-	-	-	-	-	-	-	-	-	-	3.28	4.77	4.7	-	-	-	3.2	<1	<1	<1	3.71	3.61	-	-	-	-	-	-	-	-	-	5304
5329	2	1	3	4.03	4.93	4.94	4.03	4.89	4.87	-	-	-	3.47	4.85	4.88	-	-	-	-	-	-	2.89	<1	<1	-	-	-	<1	4.1	4.1	<1	3.79	3.81	3.95	<1	<1	-	-	-	5329
5333	2	3	1	4.12	4.92	4.91	-	-	-	-	-	-	3.51	4.76	4.76	3.42	<1	<1	3.56	<1	<1	-	-	-	3.37	<1	<1	<2	4.23	3.97	<1	3.82	3.78	3.84	<1	<1	-	-	-	5333
5338	3	2	1	4.08	4.96	5	-	-	-	-	-	-	3.63	4.8</																										

Lab no	Code no	Aerobic microorg. 30 °C			Aerobic microorg. 20 °C			Contaminating microorg. In milk products			Enterobacteriaceae			Coliform bacteria 30 °C			Coliform bacteria 37 °C			Thermotolerant coliform bacteria			Escherichia coli			Presumptive Bacillus cereus			Coagulase-positive staphylococci			Enterococci			Gram-neg bacteria in dairy prod.			Lab no	
		A	B	C	A	B	C	A	B	C	A	B	C	A	B	C	A	B	C	A	B	C	A	B	C	A	B	C	A	B	C	A	B	C	A	B	C		
5419	3 2 1	4.71	4.3	3.98	-	-	-	4.73	4.29	4	3.19	3.51	3.36	-	-	-	-	-	-	-	-	-	2.98	<1	3.1	3.54	<1	<1	3.5	<1	<1	<1	4.5	4	-	-	-	5419	
5446	2 3 1	4.2	5	5.03	-	-	-	-	-	-	3.4	4.83	4.8	3.4	4.97	5.0	3.31	4.8	4.7	-	-	-	3.2	<1	<1	<1	3.71	3.9	<1	3.95	3.9	-	-	-	-	-	-	5446	
5494	2 3 1	-	-	-	-	-	-	<1	3.94	3.94	-	-	-	3.23	4	4.7	3.32	4.61	4.62	-	-	-	-	-	-	<1	3.91	3.81	-	-	-	-	-	-	-	-	-	5494	
5545	3 2 1	2.46	3.95	3.83	-	-	-	-	-	-	3.38	4.8	4.73	-	-	-	-	-	-	-	-	-	-	-	<1	3.94	4.17	<1	3.81	3.85	4.01	<1	<1	-	-	-	-	5545	
5553	2 1 3	4.08	5.03	5.05	-	-	-	-	-	-	3.36	4.84	4.9	-	-	-	-	-	-	-	-	2.96	<1	<1	<1	4.25	4.14	<1	4.02	4.01	4.02	<1	<1	-	-	-	-	5553	
5615	2 1 3	4.04	4.93	5	-	-	-	-	-	-	3.4	4.71	4.79	-	-	-	3.52	<1	<1	-	-	-	3.11	<1	<1	<1	3.64	3.86	<1	3.74	3.92	-	-	-	-	-	5615		
5632	1 3 2	4.1	4.8	4.7	-	-	-	-	-	-	3.3	4.3	4.4	-	-	-	-	-	-	-	-	-	2.9	<1	<1	<2	-	-	<2	3.7	3.6	-	-	-	-	-	5632		
5701	3 1 2	4.08	5.08	4.96	-	-	-	-	-	-	-	-	-	-	-	-	-	-	-	-	-	-	-	-	-	-	-	-	-	-	-	-	-	-	-	-	5701		
5764	2 3 1	-	-	-	-	-	-	-	-	-	-	-	-	-	-	-	-	-	-	-	-	-	-	-	-	-	-	-	-	-	-	-	-	-	-	-	5764		
5801	1 3 2	3.84	4.63	4.51	-	-	-	-	-	-	3.27	4.7	4.61	3.15	<1	<1	-	-	-	-	-	-	-	-	<2	3.9	3.85	-	-	-	-	-	-	-	-	-	-	5801	
5808	2 1 3	4	5.08	4.96	-	-	-	-	-	-	-	-	-	-	-	3.34	<1	<1	-	-	-	3.11	<1	<1	<1	<1	<1	-	-	-	-	-	-	-	-	-	5808		
5883	3 2 1	3.98	4.9	4.9	-	-	-	-	-	-	3.4	4.78	4.74	-	-	-	-	-	-	-	-	3.19	<1	<1	<2	3.87	4.08	<1	3.74	3.83	-	-	-	-	-	-	5883		
5950	1 3 2	3.97	4.75	4.74	4.01	4.83	4.66	4.07	4.94	4.89	3.03	4.68	4.58	3.22	<2	<2	3.27	<2	<2	3.35	<1	<1	3.25	<1	<1	<2	4.23	3.66	<2	3.82	3.79	3.94	<2	<2	Pos	Pos	Pos	5950	
5993	2 3 1	-	-	-	-	-	-	-	-	-	-	-	-	-	-	-	-	-	-	-	-	-	-	-	-	-	-	-	-	-	-	-	-	-	-	-	-	5993	
6109	1 2 3	-	-	-	-	-	-	-	-	-	-	-	-	-	-	-	-	-	-	-	-	-	-	-	-	-	-	-	-	-	-	-	-	-	-	-	-	6109	
6175	2 1 3	4	4.76	4.85	-	-	-	-	-	-	3.43	4.46	4.11	-	-	-	-	-	-	-	-	-	-	-	-	-	-	-	-	-	-	-	-	-	-	-	-	6175	
6224	1 3 2	4.26	5.2	5.23	-	-	-	-	-	-	3.64	4.98	4.96	-	-	-	-	-	-	-	-	-	-	-	<2	4.3	4.35	-	-	-	-	-	-	-	-	-	-	-	6224
6232	1 2 3	4.04	4.61	4.98	-	-	-	-	-	-	3.3	4.89	4.79	-	-	-	-	-	-	-	-	-	-	-	-	-	-	-	-	-	-	-	-	-	-	-	-	6232	
6253	2 3 1	4.08	5.04	4.96	-	-	-	3.54	4.99	4.98	3.46	4.98	4.93	3.41	4.91	4.9	-	-	-	-	-	3.45	<1	<1	<2	4.18	4	<1	3.88	3.89	3.91	<1	<1	-	-	-	-	6253	
6258	1 3 2	4.07	5.03	4.99	-	-	-	-	-	-	3.45	4.66	4.74	3.51	4.81	4.7	-	-	-	-	-	-	-	-	-	-	-	-	-	-	-	-	-	-	-	-	-	6258	
6343	2 1 3	4.16	4.91	4.88	-	-	-	-	-	-	-	-	-	-	-	3.55	<1	<1	-	-	-	3.34	<1	<1	<2	4.18	4.08	<2	4.06	3.85	-	-	-	-	-	-	6343		
6352	3 1 2	4	4.86	4.82	-	-	-	-	-	-	3.26	4.73	4.79	-	-	2.95	<1	<1	-	-	-	3.26	<1	<1	<2	4.08	<2	<1	3.7	3.52	3.86	<1	<1	-	-	-	-	6352	
6368	1 3 2	3.99	4.93	4.94	3.99	4.96	4.89	-	-	-	3.18	4.9	4.92	-	-	3.2	<1	<1	3.46	<1	<1	3.23	<1	<1	<2	3.97	3.99	<1	3.85	3.88	3.85	<1	<1	-	-	-	-	6368	
6456	3 1 2	4.02	4.9	4.92	-	-	-	-	-	-	3.36	4.75	4.83	3.26	<1	<1	3.42	<1	<1	-	-	3.15	<1	<1	<1	3.88	3.43	<1	3.87	3.89	3.91	<1	<1	-	-	-	-	6456	
6490	1 3 2	4	4.87	4.97	-	-	-	-	-	-	3.25	4.71	4.75	-	-	-	-	-	-	-	-	-	-	-	<2	4.29	4.26	<1	3.83	3.8	3.91	<1	<1	-	-	-	-	-	6490
6594	2 1 3	-	-	-	-	-	-	-	-	-	-	-	-	-	-	-	-	-	-	-	-	-	-	-	-	-	-	-	-	-	-	-	-	-	-	-	-	6594	
6628	1 3 2	3.99	4.81	4.82	-	-	-	-	-	-	-	-	-	3.25	4.28	3.7	-	-	-	-	-	-	-	-	-	-	-	-	-	-	-	-	-	-	-	-	-	6628	
6658	1 3 2	4.11	4.82	4.72	-	-	-	-	-	-	2.15	4.51	4.51	-	-	-	-	-	-	-	-	-	-	<1	3.84	4	-	-	-	-	-	-	-	-	Pos	-	Pos	-	6658
6686	2 1 3	-	-	-	4.02	4.87	4.88	-	-	-	3.45	4.84	4.88	-	-	-	-	-	2.91	<1	<1	3.06	<1	<1	-	-	-	<1	3.72	3.78	3.96	<1	<1	-	-	-	-	6686	
6728	2 1 3	-	-	-	-	-	-	-	-	-	-	-	-	-	-	-	-	-	-	-	-	-	-	-	<1	3.56	3.45	-	-	-	-	-	-	-	-	-	-	-	6728
6762	1 3 2	4.16	5.06	5.02	-	-	-	-	-	-	3.53	4.86	4.71	-	-	-	-	-	-	-	-	3.36	<1	<1	-	-	-	-	-	-	-	-	-	-	-	-	-	6762	
6852	2 1 3	4	5.52	4.87	-	-	-	-	-	-	-	-	-	-	-	2.81	-	-	2.81	-	-	2.78	-	-	-	-	-	-	3.45	3.57	-	-	-	-	-	-	-	6852	
6885	2 1 3	4.02	5.02	5.03	-	-	-	-	-	-	3.52	4.86	4.88	-	-	-	-	-	-	-	-	-	-	0	4.32	4.32	0	3.83	3.9	3.78	0	0	Pos	Pos	Pos	-	-	6885	
6944	1 3 2	-	-	-	5.02	5.81	5.73	-	-	-	-	-	-	-	-	4.76	0	0	-	-	-	-	-	-	-	-	-	-	-	-	-	-	-	-	-	-	-	6944	
6958	1 3 2	3.95	4.78	4.66	-	-	-	-	-	-	3.28	4.59	4.57	-	-	-	-	-	-	-	-	-	-	0	-	-	-	-	-	-	-	-	-	-	-	-	-	-	6958
6971	2 1 3	4.23	5.33	5.27	-	-	-	-	-	-	3.43	0	0	-	-	-	-	-	-	-	-	-	-	0	4.23	4.31	-	-	-	-	-	-	-	-	-	-	-	-	6971
6992	2 1 3	4.28	4.97	4.81	-	-	-	-	-	-	-	-	-	-	-	2.3	<0.48	<0.48	-	-	-	2.3	<0.48	<0.48	<2	3.64	3.51	<0.47	3.3	3.18	-	-	-	-	-	-	-	6992	
7024	1 3 2	4.18	5.13	5.11	-	-	-	-	-	-	3.46	4.98	5	-	-	-	-	-	-	-	-	-	-	-	-	-	-	-	-	-	-	-	-	-	-	-	-	7024	
7096	2 1 3	4.15	4.98	4.89	-	-	-	-	-	-	3.43	4.88	4.74	-	-	-	3.38	<1	<1	3.38	<1	<1	3.04	<1	<1	-	-	-	<1	3.85	3.85	3.86	<1	<1	-	-	-	-	7096
7182	2 1 3	4.16	5.02	5	3.98	5.05	4.91	4.06	5.07	4.95	3.35	4.92	4.8	3.02	<1	<1	3	<1	<1	-	-	-	2.9	<1	<1	-	-	-	-	-	-	-	-	-	-	-	-	7182	
7191	2 1 3	4.1	4.6	5.3	3.9	4.6	4.3	-	-	-	4.04	4.5	4.5	4.04	4.5	4.5	4.04	4.5	4.5	4.04	4.5	4.5	4.04	4.5	4.5	-	-	0	0	0	-	-	-	-	-	-	-	7191	
7207	3 2 1	4.07	5.04	5.1	-	-	-	-	-	-	3.21	4.91	4.83	-	-	-	-	-	-	-	-	-	-	-	<1	3.88	3.88	-	-	-	3.9	<1	<1	-	-	-	-	-	7207
7232	3 2 1	3.92	5.01	4.98	-	-	-	-	-	-	-	-	-	-	-	-	-	-	-	-	-	-	-	-	-	-	-	-	-	-	-	-	-	-	-	-	-	7232	
7242	3 2 1	4.02	4.87	4.84	-	-	-	-	-	-	0	4.79	4.69	-	-	-	-	-	-	-	-	-	-	-	0	3.24	3.6	-	-	-	-	-	-	-	-	-	-	-	7242
7248	2 1 3	3.92	4.7	4.7	-	-	-	-	-	-	2.86	4.78	4.59	-	-	-	2.73	<1	<1	2.99	<1	<1	2.69	<1	<1	<1	3.75	4.07	<1	3.69	3.63	3.88	<1	<1	-	-	-	-	7248
m		4.033	4.917	4.919	4.009	4.860	4.842	3.778	4.765	4.689	3.389	4.793	4.782	3.298	0	0	3.317	0	0	3.277	0	0	3.133	0	0	0	3.980	4.009	0	3.797	3.797	3.909	0						



Lab no	Code no			Aerobic microorg. 30 °C			Aerobic microorg. 20 °C			Contaminating microorg. In milk products			Enterobacteriaceae			Coliform bacteria 30 °C			Coliform bacteria 37 °C			Thermotolerant coliform bacteria			Escherichia coli			Presumptive Bacillus cereus			Coagulase-positive staphylococci			Enterococci			Gram-neg bacteria in dairy prod.			Lab no
	A	B	C	A	B	C	A	B	C	A	B	C	A	B	C	A	B	C	A	B	C	A	B	C	A	B	C	A	B	C	A	B	C	A	B	C	A	B	C	
9025	2	3	1	4.51	4.9	4.89	-	-	-	-	-	-	3.67	4.61	4.6	-	-	-	-	-	-	-	-	-	-	-	-	-	-	-	-	-	-	-	Pos	Pos	Pos	9025		
9034	1	3	2	4.1	4.9	4.9	4	5	4.9	-	-	-	3.5	4.9	4.9	-	-	-	-	-	-	-	-	-	-	-	-	-	-	-	-	-	-	-	-	-	9034			
9078	3	1	2	4.45	4.96	4.83	-	-	-	-	-	-	-	-	-	-	-	-	-	-	-	-	-	-	-	-	-	-	-	-	-	-	-	-	-	-	9078			
9217	3	2	1	4	4.9	5	-	-	-	-	-	-	3.4	5	4.8	-	-	-	-	-	-	-	-	-	2	4	3.9	-	-	-	3.7	<2	<2	-	-	-	9217			
9408	1	2	3	3.98	4.93	5.03	3.99	4.86	4.99	-	-	-	3.45	4.73	4.9	-	-	-	3.28	<1	4.72	3.27	<1	<1	3.13	<1	<1	<2	3.94	3.92	<1	3.98	3.81	-	-	-	9408			
9429	2	3	1	4.0	4.91	5.04	-	-	-	3.5	4.95	5.1	3.5	4.8	4.9	3.4	<1	<1	3.41	<1	<1	3.36	<1	<1	3.3	<1	<1	<1	3.76	3.8	<1	3.84	3.9	3.8	<1	<1	-	-	-	9429
9436	1	2	3	6.25	4.57	4.66	-	-	-	-	-	-	2.95	4.58	4.54	2.94	<1	<1	2.99	<1	<1	2.96	<1	<1	3	<1	<1	<1	3.77	3.82	<1	3.56	3.62	3.76	<1	<1	-	-	-	9436
9453	1	2	3	3.97	4.92	4.83	-	-	-	2.91	3.72	3.67	3.36	4.78	4.71	-	-	-	-	-	-	-	-	-	-	-	-	<1	4.24	4.19	<1	3.74	3.86	4	<1	<1	-	-	-	9453
9512	1	3	2	4.09	4.88	4.91	-	-	-	-	-	-	3.69	4.82	4.95	-	-	-	-	-	-	-	-	-	0	3.94	3.93	-	-	-	-	-	-	-	-	-	-	-	9512	
9559	3	2	1	4	4.88	4.85	4.06	4.91	4.9	3.2	4.48	3.6	3.52	4.83	4.72	-	-	-	3.48	4.84	4.81	-	-	-	3.34	<1	<1	<2	2.48	3.9	<1	3.72	3.62	-	-	-	Pos	Pos	Pos	9559
9655	3	2	1	4.11	4.81	4.84	-	-	-	4.08	4.83	4.83	-	-	-	3.38	<1	<1	-	-	-	-	-	-	3.11	<1	<1	<1	3.72	3.51	<1	3.74	3.83	-	-	-	-	-	-	9655
9662	3	1	2	3.96	5	4.89	-	-	-	-	-	-	3.4	4.9	4.86	3.11	<1	<1	3.11	<1	<1	-	-	-	3	<1	<1	<2	3.96	3.98	<1	3.93	3.85	3.81	<1	<1	-	-	-	9662
9747	2	3	1	3.88	4.66	4.61	-	-	-	-	-	-	-	-	-	-	-	-	-	-	-	-	-	-	-	-	-	-	-	-	-	-	-	-	-	-	-	-	9747	
9890	2	1	3	4.06	5.02	5.03	4.07	4.92	4.98	-	-	-	3.57	4.83	4.95	-	-	-	3.54	0	0	-	-	-	3.08	0	0	0	3.64	3.85	0	3.89	3.85	-	-	-	-	-	-	9890
9903	3	1	2	-	-	-	-	-	-	-	-	-	-	-	-	-	-	-	-	-	-	-	-	-	-	-	-	-	-	-	-	-	-	-	-	-	-	-	9903	
9950	1	3	2	-	-	-	-	-	-	-	-	-	-	-	-	-	-	-	-	-	-	-	-	-	-	-	-	-	-	-	-	-	-	-	-	-	-	-	9950	
n				166	166	165	34	34	34	18	18	18	138	138	137	56	56	56	94	93	93	54	53	53	117	116	116	124	122	122	111	112	112	70	71	71	12	11	12	n
Min				2.46	1.94	1.85	3.89	4.36	4.3	0	3.72	3.6	0	0	0	0	0	0	2.3	0	0	2.38	0	0	0.9	0	0	0	0	0	0	0	0	0	0	0	0	0	0	Min
Max				6.25	6.11	6.17	5.02	5.81	5.73	4.73	5.15	5.11	3.99	5.37	6.08	4.20	4.97	5.11	4.76	5.06	4.99	4.04	4.50	4.50	4.04	9.00	4.50	3.54	4.70	4.91	3.60	4.56	4.57	4.09	4.46	3.96	-	-	-	Max
median				4.03	4.93	4.94	4	4.89	4.88	4.02	4.93	4.92	3.4	4.8	4.79	3.3	0	0	3.36	0	0	3.35	0	0	3.13	0	0	0	3.98	4	0	3.82	3.81	3.92	0	0	-	-	-	median
m				4.033	4.917	4.919	4.009	4.860	4.842	3.778	4.765	4.689	3.389	4.793	4.782	3.298	0	0	3.317	0	0	3.277	0	0	3.133	0	0	0	3.980	4.009	0	3.797	3.797	3.909	0	0	pos	pos	pos	m
s				0.080	0.149	0.154	0.068	0.174	0.193	0.463	0.398	0.504	0.187	0.128	0.134	0.243	0	0	0.280	0	0	0.335	0	0	0.253	0	0	0	0.244	0.273	0	0.127	0.138	0.082	0	0	-	-	-	s
F+				0	0	0	0	0	0	0	0	0	0	0	0	0	17	17	0	19	22	0	1	1	0	3	4	3	0	0	6	0	0	0	1	1	0	0	0	F+
F-				0	0	0	0	0	0	2	0	0	1	7	6	1	0	0	0	0	0	0	0	0	0	0	0	0	6	8	0	2	2	2	0	0	0	1	1	F-
<				5	4	6	0	0	0	0	0	0	3	5	5	1	0	0	1	0	0	0	0	0	6	0	0	0	3	2	0	4	4	4	0	0	-	-	-	<
>				9	3	1	3	1	1	0	0	0	0	1	2	1	0	0	2	0	0	0	0	0	1	0	0	0	0	0	0	2	1	0	0	0	-	-	-	>
<OK				3.78	4.30	4.30	3.89	4.30	4.30	2.91	3.60	3.60	2.76	4.40	4.40	2.59	0	0	2.38	0	0	2.38	0	0	2.30	0	0	0	3.24	3.24	0	3.36	3.36	3.70	0	0	-	-	-	<OK
>OK				4.28	5.33	5.33	4.17	5.23	5.23	4.73	5.15	5.15	3.99	5.27	5.27	4.04	0	0	4.08	0	0	4.04	0	0	3.93	0	0	0	4.91	4.91	0	4.18	4.18	4.09	0	0	-	-	-	>OK

n = number of analyses performed  
Min = lowest reported result  
Max = highest reported result  
Median = median value

m = mean value  
s = standard deviation  
F+ = false positive  
F- = false negative

< = low outlier  
> = high outlier  
< OK = lowest accepted value  
> OK = highest accepted value







Lab no	Code no	Aerobic microorganisms 30 °C			Aerobic microorganisms 20 °C			Contaminating microorg. in milk products			Enterobacteriaceae			Coliform bacteria 30 °C			Coliform bacteria 37 °C			Thermotolerant coliform bacteria			Escherichia coli			Presumptive Bacillus cereus			Coagulase-positive staphylococci			Enterococci			Gram-neg bacteria in dairy prod.			Lab no
		A	B	C	A	B	C	A	B	C	A	B	C	A	B	C	A	B	C	A	B	C	A	B	C	A	B	C	A	B	C	A	B	C				
		A	B	C	A	B	C	A	B	C	A	B	C	A	B	C	A	B	C	A	B	C	A	B	C	A	B	C	A	B	C	A	B	C				
6253	2 3 1	0.584	0.822	0.266				-0.513	0.567	0.577	0.382	1.462	1.102	0.460				1.254	0	0	0	0.819	-0.033	0	0.651	0.674	0.009	0	0				6253					
6258	1 3 2	0.434	0.761	0.455							0.313	-1.015	-0.286	0.850																			6258					
6343	2 1 3	1.586	-0.049	-0.254										0.830	0	0		0.819	0	0	0	0.819	0.260	0	2.068	0.383						6343						
6352	3 1 2	-0.418	-0.383	-0.645							-0.689	-0.492	0.058	-1.310	0	0		0.503	0	0	0	0.410		0	-0.766	-2.016	-0.601	0	0			6352						
6368	1 3 2	-0.543	0.085	0.136	-0.276	0.577	0.251				-1.118	0.837	1.027	-0.418	0	0	0.548	0	0	0	0.385	0	0	-0.040	-0.070	0	0.415	0.602	-0.723	0	0	6368						
6456	3 1 2	-0.167	-0.116	0.006							-0.154	-0.335	0.356	-0.157	0	0	0.367	0	0		0.069	0	0	-0.408	-2.121	0	0.572	0.674	0.009	0	0	6456						
6490	1 3 2	-0.418	-0.316	0.331							-0.743	-0.648	-0.241								0	1.270	0.919	0	0.257	0.020	0.009	0	0			6490						
6594	2 1 3													-0.198																			6594					
6628	1 3 2	-0.543	-0.718	-0.645																													6628					
6658	1 3 2	0.960	-0.651	-1.295							-4.000	-2.211	-2.031								0	-0.572	-0.033							0	0	6658						
6686	2 1 3				0.162	0.059	0.199				0.329	0.368	0.729				-1.095	0	0		-0.287	0	0			0	-0.608	-0.126	0.619	0	0	6686						
6728	2 1 3																																	6728				
6762	1 3 2	1.586	0.956	0.657							0.757	0.524	-0.539								0.898	0	0										6762					
6852	2 1 3	-0.418	4.000	-0.319										-1.810			-1.393				-1.393					-2.733	-1.652						6852					
6885	2 1 3	-0.167	0.688	0.722							0.704	0.524	0.729										0	1.392	1.138	0	0.257	0.747	-1.576	0	0	0	6885					
6944	1 3 2				4.000	4.000	4.000							4.000	0	0																		6944				
6958	1 3 2	-1.044	-0.919	-1.686							-0.582	-1.586	-1.583																					6958				
6971	2 1 3	2.463	2.763	2.283							0.221												0	1.024	1.102								6971					
6992	2 1 3	3.065	0.340	-0.736										-3.630	0	0					-3.288	0	0	0	-1.378	-1.846	0	-3.914	-4.000				6992					
7024	1 3 2	1.837	1.424	1.242							0.382	1.462	1.624										0	1.024	0.772								7024					
7096	2 1 3	1.461	0.420	-0.189							0.221	0.681	-0.315				0.224	0	0	0.309	0	0	-0.366	0	0	0	0.415	0.383	-0.601	0	0		7096					
7182	2 1 3	1.586	0.688	0.527	-0.422	1.096	0.355	0.610	0.768	0.517	-0.207	0.993	0.132	-1.143	0	0	-1.132	0	0		-0.919	0	0										7182					
7191	2 1 3	0.835	-2.124	2.479	-1.590	-1.496	-2.804							3.049			2.579			2.279		3.584												7191				
7207	3 2 1	0.459	0.822	1.177							-0.957	0.915	0.356										0	-0.408	-0.473								7207					
7232	3 2 1	-1.420	0.621	0.396																														7232				
7242	3 2 1	-0.155	-0.343	-0.528																			0	-3.015	-1.502									7242				
7248	2 1 3	-1.420	-1.454	-1.426							-2.832	-0.101	-1.434				-2.095	0	0	-0.856	0	0	-1.748	0	0	0	-0.940	0.223	0	-0.844	-1.216	-0.357	0	0	7248			
7253	1 3 2													0.509	0	0					0.029	0	0	0	0.247	0.516								7253				
7334	2 1 3	-1.420	-0.718	-0.710										-1.739							-4.000	0	0	0	0.001	-1.205	0	-0.372	-0.635					7334				
7543	2 3 1	0.584	-3.396	-3.768	-1.006	-2.878	-2.804							-2.007	0	0					-1.489	0	0	-2.677	0	0	0	-3.130	0	0				7543				
7564	1 3 2	0.083	0.822	-0.124				0.566	0.592	0.696	-0.475	0.681	0.207	0.402	0	0	0.309	0	0	0.977	0	0												7564				
7596	2 3 1	-0.255	-4.000	-1.862	-1.313	-0.643	-0.526				-1.332			-0.725	0	0	0.195	0	0	-0.524	0	0	0	0.251	0.117	0	-0.703	-1.267	-2.454	0	0			7596				
7627	3 1 2	0.083	0.956	0.722										1.508									0	-0.572	-1.681									7627				
7631	2 3 1	-0.794	-0.183	-0.254							0.329	-0.257	-0.166	0.624																				7631				
7640	3 1 2	0.960	-1.120	0.266	-0.130	-1.438	0.355				-0.368	-0.648	-0.464	-0.609	0	0	-0.062	0	0	-0.089	0	0	0	0.819	0.992	0	-1.867	-0.780	0.375	0	0		7640					
7688	2 3 1	-0.293	-0.316	-1.100							-0.850	-0.648	-1.359	0.008	0	0	0.331	0	0	0.369	0	0	1.056	0	0	0	-0.818	-0.583	0	0.572	1.547	-1.576	0	0	7688			
7728	2 1 3	-1.044	0.353	0.331	-0.130	0.232	0.147							1.615	0	0	1.473	0	0	2.517	0	0	0	1.147	1.175	0	-0.451	-0.271						7728				
7750	1 2 3	0.083	0.956	0.917							2.685	1.150	0.878				1.651						0	-0.122	0.333									7750				
7825	1 3 2	-0.756	0.681	-0.482							-1.396	0.634	0.035				-0.826	0	0	0.009	0	0				0	0.446	0.136						7825				
7876	3 2 1	-0.042	0.554	0.461							0.007												0	0.247	0.223	0	0.257	0.165	0.253	0	0			7876				
7930	1 2 3	-0.167	0.554	0.071							0.489	0.446	0.953	0.460	0	0	0.509	0	0	0.189	0	0	0.029	0	0	0	1.229	1.651	0	0.415	0.747	-0.113	0	0	7930			
7940	2 3 1	0.083	0.822	0.592										0.008	0																				7940			
7962	2 1 3	-1.796	0.219	-0.775							-3.367	0.290	-0.614	-1.637			-1.703			-1.274	0	0	-1.116	0	0	0	-1.186	-1.938	0	0.494	-1.071	-4.000	0	0	7962			
7968	2 1 3	0.334	0.755	-0.124	-1.736	0.577	-0.474				-0.475	1.618	0.505	-0.280	0	0	0.081	0	0	0.607	0	0	1.293	0	0	0	-0.122	-0.033	0	0.415	-0.053	0.619	0	0	7968			
7984	1 3 2	-1.671	-2.124	-2.922							-0.046	-1.507	-2.329										0	-0.572	-0.033								0	0	0	7984		
8066	3 1 2				-0.130	-0.632	0.147				-1.118	0.134	0.058				0.295	0	0		1.214	0	0	0	-4.000	-4.000	0	-2.261	-2.816	-4.000	0	0			8066			
8068	2 3 1	-0.668	0.353	-0.450	-0.422	0.174	0.303				-0.528	-0.492	-0.912	-0.527	0	0	0.474	0	0	0.040	0	0	0.266	0	0	0	-1.513	-1.278	0	-0.057	-1.071	0.375	0	0	8068			
8105	3 2 1	-0.293	0.956	1.242										0.152									-0.010	0	0										8105			
8213	1 3 2	-0.167	0.219	0.461							0.114	-1.351	-0.987										0	0.533	1.468									0	0	8213		
8228	2 3 1	0.334	-0.450	0.331	3.959	-2.187	-1.872				0.061	-4.000	-4.000	0.090							0.398	0	0	0	-1.513	-1.169									8228			
8260	3 1 2	0.083	-0.249	-0.580							0.221	0.446	-0.166	0.131	0	0							1.096	0	0	0	-0.408	-0.033	0	0.100	-0.853	-0.357	0	0	8260			
8313	1 2 3	-1.195	-0.109	-0.118							0.																											



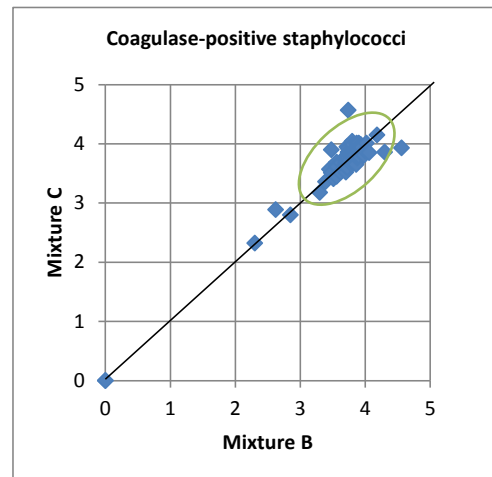
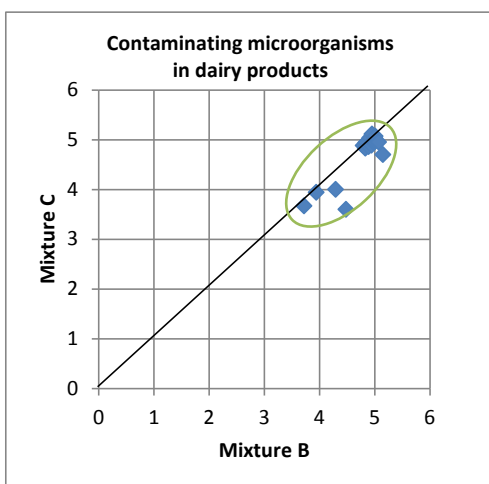
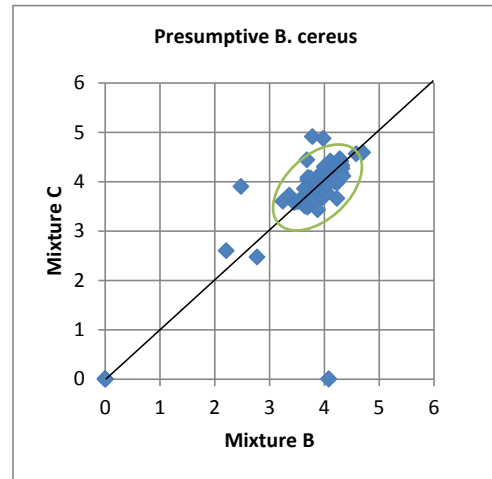
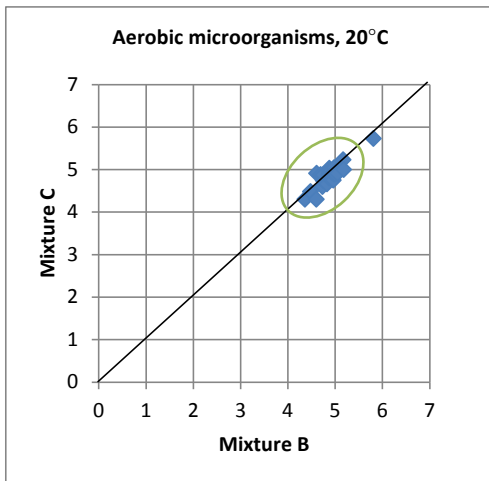
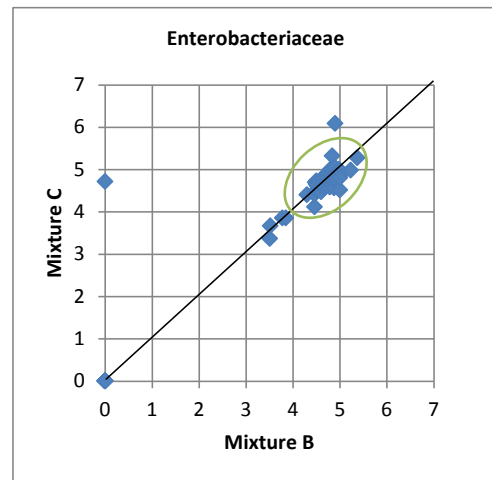
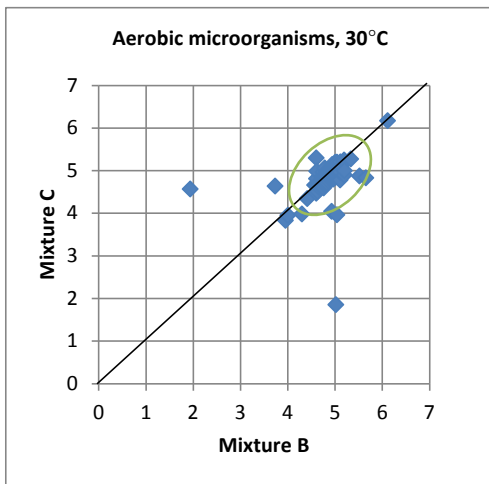

**Annex 3.** Youden plot for analyses of mixtures B and C. Values outside the results cluster (circled) but still similar or close to the 45° line are from laboratories that obtained results systematically deviating from the overall outcome. Few laboratories obtained different results for the same analyses performed on the two mixtures (away from the 45° line).

## **Internal and external control for microbiological analyses of food and drinking water**

All analytical activities require work of a high standard that is accurately documented. For this purpose, most laboratories carry out some form of internal quality assurance, but their analytical work also has to be evaluated by an independent party. Such external quality control of laboratory competence is commonly required by accreditation bodies and can be done by taking part in proficiency testing (PT).

In a proficiency test, identical test material is analysed by a number of laboratories using their routine methods. The organiser evaluates the results and compiles them in a report.

### **The National Food Agency's PT program offers**

- External and independent evaluation of laboratories analytical competence.
- Improved knowledge of analytical methods with respect to various types of organisms.
- Expert support.
- Tool for inspections regarding accreditation.
- Free extra material for follow-up analyses.

For more information visit our website: [www2.slv.se/absint](http://www2.slv.se/absint)

### **The National Food Agency's reference material**

As a complement to the proficiency testing, National Food Agency produces also reference material (RM) for internal quality control: a total of 8 RM for food and drinking water microbiological analyses, including pathogens, are available.

Information available on our website: [www.livsmedelsverket.se/en/RM-micro](http://www.livsmedelsverket.se/en/RM-micro)